

NSK-RHP is part of the international NSK group who are one of the world's leading manufacturers of rolling bearings, automotive components and mechatronic products.

The group has more than 30 manufacturing units around the world, employing over 21,000 people and is represented by sales offices and Authorised Distributors almost everywhere.

Our manufacturing programme includes bearings from 1mm bore to 5 metres, covering virtually all conceivable application areas. Self-Lube is an integral part of our comprehensive product range.

Every care has been taken to ensure that the information in this publication is accurate but no liability can be accepted for any errors or omissions.

© Copyright NSK-RHP 1997
The contents of this publication are the copyright of the publishers

Introduction

Self-Lube is the registered trademark for the RHP range of wide inner ring bearings and mounted bearing units.

Self-Lube units provide simple and effective bearing arrangements capable of accommodating moderate initial misalignment from mounting errors. They are easily mounted onto commercial shafting and are particularly useful where fabricated machine frames are employed.

The units are available in a variety of pillow block and flange mounted configurations with one piece cast iron or two piece pressed steel housings.

Self-Lube inserts are wide inner ring ball bearings that are effectively and efficiently sealed. Simple fitting onto standard shafting is provided for by means of eccentric locking collar, set screws or adapter sleeve.

The reliability, simplicity and ease of assembly of items in the Self-Lube range has resulted in their popularity for agricultural, extraction and construction machinery as well as process and automation equipment.

Product Selection

The purpose of this catalogue is to introduce the RHP Self-Lube range and provide the necessary technical information for assisting in selecting the most appropriate Self-Lube product for most applications. NSK-RHP can provide many other items which are covered in further publications and can provide additional advice.

Examples of calculation methods used when making a selection are included within this catalogue together with advice and information about mounting.

In line with our policy of continuous improvement, we reserve the right to amend the details in this catalogue without prior notice. If you have any doubts when making an application selection, or if you require additional information, please contact NSK-RHP.

NSK-RHP UK Ltd.

Mere Way, Ruddington, Nottingham,
NG11 6JZ, England.
Tel: 0115 936 6600 Fax: 0115 936 6702

NSK-RHP Ibérica S.A.

Calle De La Hidraulica,
5, Poligono Industrial "La Ferreria",
08110 Montcada I Reixac, Barcelona, Espana.
Tel: (93) 575 4041 Fax: (93) 575 0520

NSK-RHP Deutschland GmbH

Verwaltung Ratingen, Harkortstrasse 15,
40880 Ratingen, Deutschland.
Tel: 0 21 02 4810 Fax: 0 21 02 48 12 29

NSK-RHP Italia S.p.A.

Via XX Settembre, 30, 20024 Garbagnate,
Milanese (Milano), Italia
Tel: (02) 995 191 Fax: (02) 9902 5778

NSK-RHP Nederland B.V.

Bouwerij 81, 1185 XW Amstelveen,
Nederlands.
Tel: (020) 647 0711 Fax: (020) 645 5689

NSK-RHP France S.A.

Quartier De L'Europe,
2 Rue Georges Guynemer,
78283 Guyancourt, Cedex, France.
Tel: 01 30 57 39 39 Fax: 01 30 57 00 01

NSK-RHP Europe Ltd

Warsaw Liaison Office,
Oddzial w Warszawie,
UL. Migdalowa 4 Lok. 73,
02-796 Warsaw, Poland
Tel: 48-22-645-1525 Fax: 48-22-645-1529

NSK-RHP Rulmanlari Orta Dogu Ticaret Limited Sirketi

Eski Üsküdar Cad., Çayir Yolu Sok.,
Nora Center, Kat 1.
81090 İçerenköy-Istanbul, Turkey
Tel: 90 216 463 61 56 Fax: 90 216 463 61 47
3 Te Apunga Place, Mt. Wellington, Auckland,
New Zealand.
Tel: (09) 276 4992 Fax: (09) 276 4082

NSK-RHP Australia Pty. Ltd.

11 Dalmore Drive, Scoresby, Victoria 3179,
Australia.
Tel: (03) 9764 8302 Fax: (03) 9764 8304

NSK-RHP South Africa (Pty) Ltd.

25 Galaxy Avenue, Linbro Business Park,
Sandton, P.O.Box 1157, Kelvin, 2054,
South Africa
Tel: (011) 458 3600 Fax: (011) 458 3608

NSK-RHP American Distribution Centre Inc.

5201 Blue Lagoon Drive, Suite 670, Miami,
Florida 33126, USA
Tel: 305-261 7824 Fax: 305-261 6246





























NSK Singapore (Pte) Ltd.





48 Toh Guan Road #02-03
Singapore 608837
Tel: 65 278 1711 Fax: 65 273 0253

NSK Corporation

3861 Research Park Drive, P.O. Box 1507
Ann Arbor, M1 48108 USA
Tel: 734-761-9500 Fax: 734 761 9510

Introduction	2
Product Selection	3
Summary of Self-Lube types	6
The Self-Lube product range	9
The Self-Lube Protector	10
Sealing, cages and lubrication	11
Shaft locking arrangements	13
Set screw thread and tightening torques	14
Mounting instructions for Self-Lube Bearing units	15
Bearing load ratings and endurance	17
Examples of bearing calculations	19
Loading ratios	20
Housing loads	21
Tolerances and speeds	22
Cast iron Self-Lube units	24
Pressed steel Self-Lube units	70
Self-Lube Bearing inserts	80
Sealed radial ball bearing with spherical outside diameter	93
Disc harrow bearings	94
Self-Lube Protector details	102
Additional products	103
Conversion tables	105
Notes	108

Housing type ▼		Insert type			
					
		1000G	1000DECG	1200G	1200DECG
Cast Iron one piece		24	NP-DEC	NP-A	NP-EC
		30	SL-DEC	SL-A	SL-EC
		32			
		38	SNP-DEC	SNP-A	SNP-EC
		38	CNP-DEC	CNP-A	CNP-EC
		38	SF-DEC	SF-A	SF-EC
		40			
		44	SFT-DEC	SFT-A	SFT-EC
		46			
		50	LFTC-DEC	LFTC-A	LFTC-EC
		52	FC-DEC	FC-A	FC-EC
		54			
		56	ST-DEC	ST-A	ST-EC
		58			
	62		BT-A	BT-EC	
	64	SLC-DEC	SLC-A	SLC-EC	
	66				
	68				
	68				
Pressed steel two piece		70	SLFE-DEC	SLFE-A	SLFE-EC
		72	SLFT-DEC	SLFT-A	SLFT-EC
		74	SLFL-DEC	SLFL-A	SLFL-EC
		76	LPS-DEC	LPS-A	LPS-EC
	78	LPSR-DEC	LPSR-A	LPSR-EC	

Insert type					Page
					
T1000G	T1000 DECG	1000-GFS	1000DECGFS	1000-KG	
TNP	TNP-DEC	NP-FS	NP-DECFS	NP1000-K	28
TSL	TSL-DEC	SL-FS	SL-DECFS	MP1000-K	34
TMP		MP-FS			
TSNP	TSNP-DEC	SNP-FS	SNP-DECFS		
TCNP	TCNP-DEC	CNP-FS	CNP-DECFS		
TSF	TSF-DEC	SF-FS	SF-DECFS	MSF1000-K	42
TMSF		MSF-FS			
TSFT	TSFT-DEC	SFT-FS	SFT-DECFS	MSFT1000-K	48
TMSFT		MSFT-FS			
TLFTC	TLFTC-DEC	LFTC-FS	LFTC-DECFS		
TFC	TFC-DEC	FC-FS	FC-DECFS		
TMFC		MFC-FS			
TST	TST-DEC	ST-FS	ST-DECFS	MST1000-K	60
TMST		MST-FS			
TBT		BT-FS			
TSLC	TSLC-DEC	SLC-FS	SLC-DECFS		
TMSC		MSC-FS			
TSCHB		SCHB-FS			
TSCH		SCH-FS			
TSLFE	TSLFE-DEC	SLFE-FS	SLFE-DECFS		
TSLFT	TSLFT-DEC	SLFT-FS	SLFT-DECFS		
TSLFL	TSLFL-DEC	SLFL-FS	SLFL-DECFS		

Under the heading of Self-Lube bearings there are two basic products: the Self-Lube bearing insert and the Self-Lube bearing unit.

Self-Lube bearing insert

The Self-Lube bearing insert, commonly known as a wide inner ring bearing, is designed to suit the wide range of housings offered by RHP in the Self-Lube bearing unit range and is also suitable for applications where the user's own housing is preferred.

They are basically deep-groove ball bearings to the internationally popular 6200 series configuration with integral design features making them more functional and versatile than the standard ball bearing. The radial internal clearance is C3 for standard bearing inserts and they are offered with either parallel or spherical outside diameter outer rings with the latter being the type fitted in the bearing unit.

The integral design features of the bearing insert such as shaft locking, seals and lubrication are explained in the following pages.

Variations of the basic series which have been designed for specific applications are also included in this catalogue, e.g. Triple Lip Seal inserts, Disc Harrow bearings and the 1726200-2RS series.

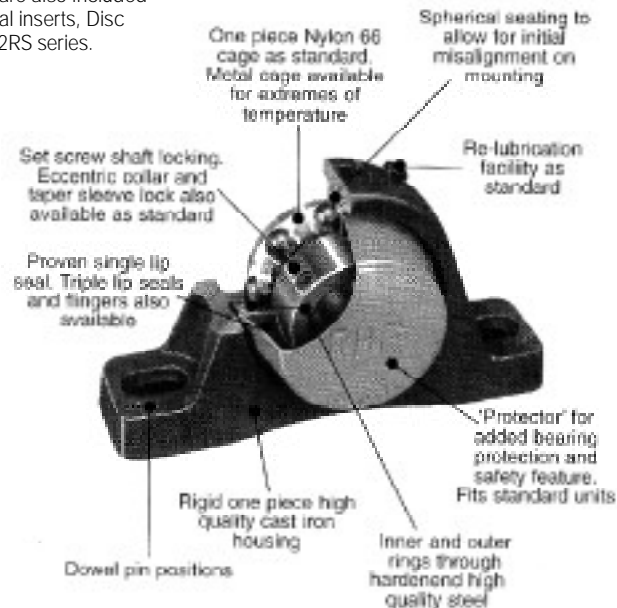

Self-Lube bearing unit

The RHP range of Self-Lube bearing units offer a wide choice of cast iron, pressed steel or synthetic rubber housings fitted with the full range of Self-Lube bearing inserts, with spherical outside diameter. They will accommodate initial housing misalignment up to 0,030 radians but are not recommended for running misalignment in excess of 0,001 radians.

The general housing types are pillow blocks, flange units, take-up units, cartridge units and hanger units. Choice is very much determined by the requirements of the application, although the aesthetic appearance of the machine design is often an important consideration. Self-Lube units have been designed to meet the needs of both criteria.

The castings are made from high-quality cast iron, and finished on all unmachined surfaces with an electrostatic air drying paint.

Pressed steel housings are made from mild steel strip, and are zinc plated. Rubber housings are moulded in antistatic nitrile rubber.

Additional Products

RHP does recognise the need for the 'tailor made' and is always willing to help customers who have a requirement for something out of the ordinary, commensurate with meeting certain price and volume criteria. The glossary of some of the special inserts and units which RHP currently manufactures is shown on pages 103 to 104.

List of common Prefixes and Suffixes

Prefixes

- B Unit or bearing insert supplied without locking collar.
- J Grease groove on the side of the bearing insert nearest to the locking device.
- T Triple lip sealed bearing insert.

Suffixes

- A Unit fitted with set screw lock insert with flush inner ring on one side.
- C4 Radial clearance greater than C3.
- CG Parallel outside diameter insert with grease groove and snap ring fitted.
- DEC Eccentric collar lock with extended inner ring.
- DL Double locking inner ring - 4 set screws (2 each end).
- EC Eccentric collar lock with flush inner ring on one side.
- FS Bearing insert fitted with flinger seals.
- G Bearing insert having relubrication facility.
- H Bearing insert with hexagon bore.
- HLT High and Low temperature bearing insert.
- J Bearing insert with pressed steel cage.
- K Bearing insert with tapered bore.
- L Larger than normal unit for the basic bore size.
- R Smaller than normal unit for the basic bore size.

Self-Lube Protector

The RHP Self-Lube Protector is designed to protect the machine operator from the dangers of rotating shaft ends and the external surfaces of the bearing from contamination.

The Protector is made from good quality mild steel and coated with enamel paint making it robust, attractive and long lasting. It is easy to fit and can be removed without breakage or deformation thus allowing it to be refitted time after time.

Standard Self-Lube inserts with spherical outside diameters have a 'groove' in the outer ring on the opposite side from the grease groove. The Protector has two claws which locate through the casting loading slots with the 'groove' in the outer ring. This provides a very secure lock and makes the Protector difficult to dislodge. The user of Self-Lube units is not required to purchase special bearings or provide any additional locking device.

The Protector can be removed by inserting a form of lever device into the small hole in one of the claws and exerting slight pressure outwards. This disengages the claw from the outer ring 'groove'. A replaceable cover for the hole is provided.



(Patented)

Single lip seal

The standard Self-Lube sealing arrangement consists of a nitrile and fabric sealing element sandwiched between two metal pressings. This has been successfully proven over the years on a wide variety of applications.

The 'S' type seal now introduced incorporates further design developments. The nitrile seal (black in colour) is bonded to a strong steel former firmly secured in the bearing outer ring. The flexible sealing lip contacts the fine ground finish of the inner ring to give low friction with effective sealing.

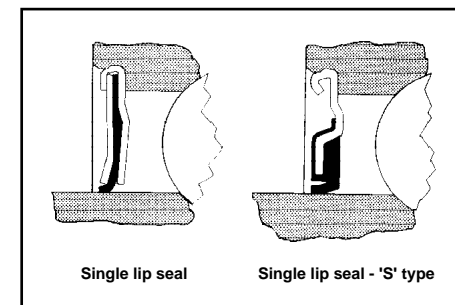

Flinger Seal

Where extra protection is required without loss of bearing catalogue speed, the 'Flinger seal' is ideal. It consists of a steel flange to which is bonded a flexible nitrile sealing lip.

They are offered for the 1000 and 1000DEC types and are identified with the suffix FS (e.g. 1025-25GFS, NP25FS).

Please check availability.

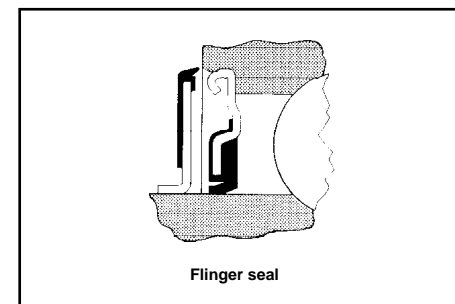

Triple lip seal

For applications with a high degree of contamination, the specially developed RHP triple lip seal is recommended. It consists of a one-piece moulded nitrile seal with three sealing lips, bonded to a protective steel outer pressing which is strongly secured in the outer ring making a highly efficient sealing arrangement. It is not recommended for high speeds. See pages 88 to 90 inclusive.

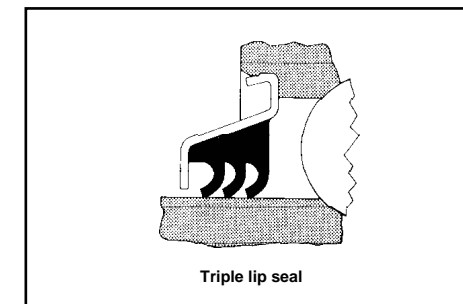

Cages

Plastic cages. All standard Self-Lube bearing inserts are fitted with nylon 66 cages.

Steel cages. Bearings specified to operate at extremes of temperature are fitted with steel cages.

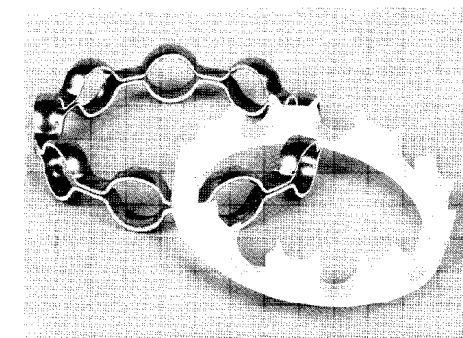

Lubrication

Self-Lube bearings are factory charged with the correct amount of grease and do not require a further grease charge when being fitted.

Re-lubrication is not normally necessary except when operating at extremes of temperature, speed, loading, extended running, or where excessive wet or dirty conditions exist. The re-greasing cycle is dependent upon each application, and in such cases please consult NSK-RHP, or refer to the RHP Technical Handbook.

All cast iron units are fitted with a standard re-greaseable bearing insert. The housings are provided with a tapped hole to facilitate relubrication and supplied with a plastic plug and grease nipple. All such units are tapped 1/4" UNF except for the FC series which is tapped M5 x 0,8 pitch.

Note: A grease adapter (ref. 1003G) is available to fit the 1/4" UNF tapped hole to give 1/8" BSP female fitting.

To make the unit re-greaseable, insert grease nipple provided.

The pressed steel housings are not provided with a re-greasing facility.

Suitable greases for re-lubricating standard Self-Lube bearings are premium quality lithium based of No. 2 1/2 or No.3 consistency. See table below.

Unit	Unit temperature range	Grease	Supplier
Standard	-20°C to +110°C	Nerita HV	Shell
		Albida R2	Shell
		Alvania R3	Shell
		Alvania RA	Shell
		LZR2	Silkolene
		Energrease LS3	BP
		Beacon 3	Esso Petroleum
		Multis Special 3	Total
		Lupus A3	Century Oils
		Mobilux 3	Mobil Oil
Low Temperature	down to -40°C	Kluber Asonic HQ72-102	
High Temperature	up to 180°C	Kluber Asonic HQ72-102	

High and Low temperature inserts/units

Bearing inserts and units can be supplied for operating up to a maximum temperature of +180°C and down to a minimum temperature of -40°C.

Re-greasing is essential for these bearings using the recommended grease shown in the table. Other greases must not be used.

These bearings are fitted with a steel cage and provided with C5 radial internal clearance as standard.

When ordering please add the suffix HLT to the insert or unit reference, e.g. NP25EC HLT.

Set screw lock

This locking arrangement consists of two knurled cup-point, self-locking, socket-head set screws fitted in the extended inner ring.

For normal loads and moderate speeds simply mount the bearing unit into position and tighten down the set screws to the recommended torque value.

Additional security can be achieved by spot drilling the shaft to accommodate the set screw point. When spot drilling, first remove the set screw and locate the unit in position on the shaft. Select a drill the size of the inner ring threads minor diameter, and drill through this hole into the shaft to the depth of the drill point.

Replace the set screw and tighten onto the shaft in the normal manner.

The recommended tightening torques for the set screws are given on page 14.

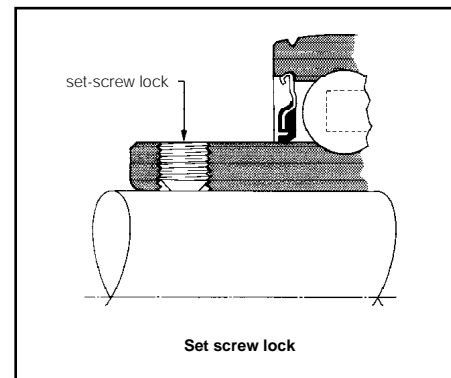

Eccentric collar lock

This type of lock consists of an eccentric diameter formed on the extended inner ring of the bearing which engages a similarly formed eccentric diameter in the bore of a separate collar.

Locking is achieved by turning the collar in the direction of shaft rotation until the eccentric diameters of both collar and inner ring are fully engaged. The collar is provided with a blind hole to facilitate tightening when locking the bearing to the shaft. The set screw when tightened to the recommended torque values on page 14 prevents the collar 'backing off' in service.

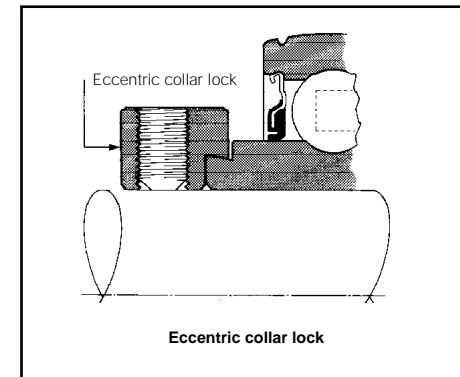

Taper sleeve lock

This locking arrangement which incorporates a standard taper adapter sleeve, locknut and lock washer, is recommended when a positive concentric (shaft) lock is required.

When fitting the bearing to the shaft, care must be taken to ensure that the locknut is not overtightened as this can eliminate the bearing internal clearance, resulting in premature failure. A lockwasher is provided which prevents the locknut 'backing off' when one of the tabs is engaged with the corresponding notch in the locknut. (See page 15 for fitting instructions.)

The recommended tightening torques for the locknuts are given on page 14.

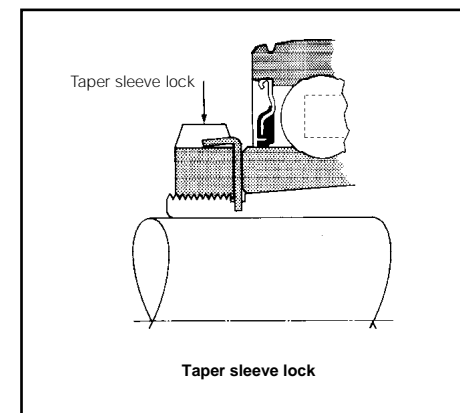

Set screw thread and size

Basic bearing insert reference	Series			
	1000G, 1100, 1200G, 1300		1000 DECG, 1100DEC, 1200ECG, 1300EC	
	Inch bore diameters	Metric bore diameters	Inch bore diameters	Metric bore diameters
1017	1/4UNF	M6 x 0,75	1/4UNF	M6 x 0,75
1020	1/4UNF	M6 x 0,75	1/4UNF	M6 x 0,75
1025	1/4UNF	M6 x 0,75	1/4UNF	M6 x 0,75
1030	1/4UNF	M6 x 0,75	5/16UNF	M8 x 1,00
1035	1/4UNF	M6 x 0,75	3/8UNF	M10 x 1,25
1040	5/16UNF	M8 x 1,00	3/8UNF	M10 x 1,25
1045	5/16UNF	M8 x 1,00	3/8UNF	M10 x 1,25
1050	5/16UNF	M8 x 1,00	3/8UNF	M10 x 1,25
1055	3/8UNF	M10 x 1,25	3/8UNF	M10 x 1,25
1060	3/8UNF	M10 x 1,25	3/8UNF	M10 x 1,25
1065	3/8UNF	M10 x 1,25	3/8UNF	M10 x 1,25
1070	3/8UNF	M10 x 1,25	3/8UNF	M10 x 1,25
1075	7/16UNF	M12 x 1,25	7/16UNF	M12 x 1,25
1080	7/16UNF	M12 x 1,25	-	-
1085	1/2UNF	M12 x 1,25	-	-
1090	1/2UNF	M12 x 1,25	-	-
3095	1/2UNF	M12 x 1,25	-	-

Set screw tightening torques and maximum axial loads

Set screw size	Socket/Allen key size (across flats)	Recommended maximum tightening torque		Set screw maximum axial load	
		newton metres (Nm)	lbf-inches	newtons (N)	lbf
1/4UNF	1/8"	6,8	60	2500	560
5/16UNF	5/32"	12,4	110	3500	785
3/8UNF	3/16"	22,6	200	4500	1010
7/16 UNF	7/32"	31,6	280	7500	1685
1/2UNF	1/4"	45,2	400	9000	2025
M6 x 0,75	3mm	5,7	50	2500	560
M8 x 1,00	4mm	12,4	110	3500	785
M10 x 1,25	5mm	27,1	240	5000	1235
M12 x 1,25	6mm	38,4	340	8000	1800

Note For axial loads in excess of the values listed a shouldered shaft against the face of the inner ring is recommended. Maximum axial loads with a shouldered shaft are shown on page 21.

Recommended tightening torques for adapter sleeve units

Sleeve bore size	Tightening torques	
	Nm	lbf-ins
20mm, 3/4"	30	265
25mm, 15/16", 1"	40	355
30mm, 1 1/8", 1 3/16"	50	440
35mm, 1 1/4", 1 3/8"	60	530
40mm, 1 7/16", 1 1/2"	65	575
45mm, 1 1/16", 1 3/4"	75	660
50mm, 1 15/16" 2"	85	750

General notes on mounting

To prevent the possibility of damage to the bearing due to faulty installation, Self-Lube housings should always be bolted to the equipment and secured in position together with the shaft assembly before locking the inner rings onto the shaft. Failure to do so could result in axial preload leading to premature failure.

Clean, straight shafting should always be used, with a chamfered shaft end to provide a lead into the bearing bore.

It is important to ensure that the set screws are clear of the bearing bore before the unit is assembled onto the shaft.

The Self-Lube bearings will normally slide over the shaft but if a force fit is required a correctly sized brass tube should be used to press against the inner ring face. Never hammer the end of the inner ring or housing as this may damage the bearing.

When a shaft mounting is complete, turn the shaft to make certain it rotates freely without binding.

When using the spot drill method for the set screw seating, be careful not to damage the screw threads of the inner ring with the drill.

All cast iron bearing housings should be mounted, whenever possible, so that they are in compression under load, not tension, i.e. take-up units should be mounted with the adjuster pushing against the housing for take-up adjustment.

Cast iron housings should not be used on applications with heavy reversing or pulsating axial loads.

Special consideration should be given to applications with long bearing centre distances, or cases where the bearing could be subject to induced loads caused by differential expansion due to temperature change. In such cases please consult NSK-RHP.

Additional notes on mounting Self-Lube adapter sleeve units

- 1 First bolt the Self-Lube housing to the equipment and clean the shaft and sleeve bore of any oil or grease.
- 2 Position the shaft within the unit and tighten up the locknut by hand. If the sleeve assembly turns on the shaft tap the sleeve into the bearing to give a positive grip. Tighten locknut to recommended torque value given on page 14.
- 3 Where torque spanner facilities are not available a blunt drift and small hammer may be used to tighten the nut.
- 4 Check that the bearing rotates freely, to ensure that the internal clearance has not been totally removed and that preload has been avoided.
- 5 Finally, secure the nut with the appropriate tab on the locking washer.
- 6 After 100 hours running it is advisable to check the tightness of the locknut.

Self-Lube cast iron pillow block units

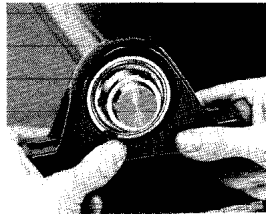

1 Relieve set screws clear of the bore and slide bearing onto the shaft.

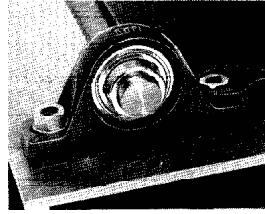

2 Bolt the unit down on to a flat surface but do not over-tighten.

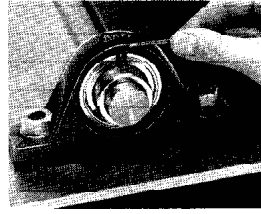

3 Tighten set screws to recommended torque.

Self-Lube pressed steel flange units

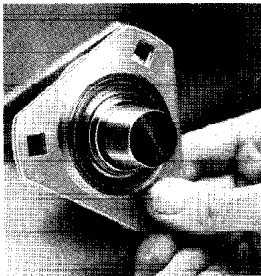

1 Assemble bearing and housing and slide onto the shaft. Do not engage collar.

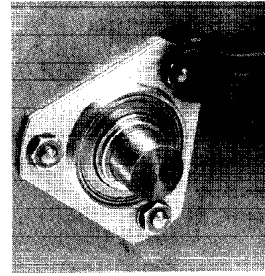

2 Lightly tighten bolts, repeat at other end of shaft and then finally tighten bolts on both sides.

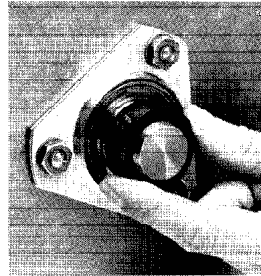

3 Engage the eccentric collar in direction of shaft rotation.

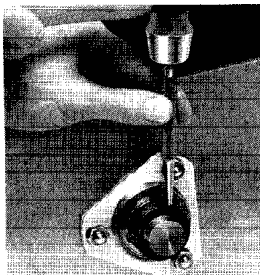

4 Tighten collar with drift pin.

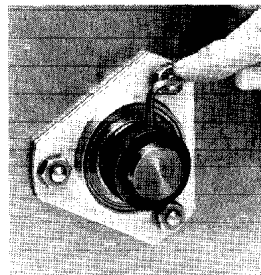

5 Tighten collar set screw to recommended torque.

Dynamic load ratings

The RHP dynamic load ratings given in this catalogue and the relationship between these and bearing fatigue life are based on the ISO standard 281. (1990)

Basic dynamic radial load rating C_r

This is defined as the load that can be applied to the bearing to give a basic L_{10} rating life of one million revolutions. This is the life associated with 90% reliability which has been found by experience to be acceptable for normal engineering bearing applications. The majority of the bearings attain a much longer life and the median life is approximately five times the L_{10} life. Ratings for each series are given in the bearing tables and are used to calculate life for radial loads of constant magnitude and direction.

Equivalent dynamic radial load P_r

For applications where axial and radial loads are present they must be converted into a single equivalent radial load P_r and calculated as follows, where:

- F_r = actual radial load (N)
- F_a = actual axial load (N)
- Y = axial factor from table 18.2
- C_{or} = basic static load rating
- C_r = dynamic radial load rating
- f_o = axial load factor

Note: Axial load F_a must not exceed $0,5 C_{or}$. Select f_o from table 18.1 for the appropriate bearing insert. Calculate $\frac{f_o F_a}{C_{or}}$ and obtain the value

of Y from table 18.2

Calculate P_r where:

$$P_r = F_r$$

or

$$P_r = 0,56 F_r + Y F_a$$

Use whichever P_r value is the greatest.

Relationship between load and life

Having determined the equivalent load P_r the nominal L_{10} bearing life is calculated as follows:

$$L_{10} \text{ life in hours} = \left(\frac{C_r}{P_r}\right)^3 \times \frac{10^6}{60n}$$

where n = bearing operating speed (rev/min).

Alternatively, by using the loading ratio $\frac{C_r}{P_r}$ the

bearing L_{10} life can be estimated by reading off directly from the tables on page 20 under the appropriate speed column.

Basic static load rating C_{or}

This value is calculated in accordance with ISO standard 76 - 1987. Ratings for each series are given in the bearing tables.

Static equivalent radial load P_{or}

When static axial and radial loads are applied to a bearing these must be converted to an equivalent static radial load P_{or} where:

$$F_{or} = \text{actual static radial load (N)}$$

$$F_{oa} = \text{actual static axial load (N)}$$

Calculate P_{or} where:

$$P_{or} = F_{or}$$

or

$$P_{or} = 0,6 F_{or} + 0,5 F_{oa}$$

Use whichever P_{or} value is greater, but this value **should not exceed** the bearing static radial load rating C_{or} .

Service factors

It is customary when calculating bearing life to include application factors to allow for fluctuations in loading that occur in service, and from experience the following may be used as a guide.

For steady and light shock loads multiply load by 1.2 to 1.5.

For moderate shock loads multiply load by 1.7 to 2.0.

When selecting the size of bearing for a given load, the calculated life should conform to the L_{10} lives shown below:

Machines in use 8 hours/day - not fully utilised - 10,000 to 20,000 hours.

Machines in use 8 hours/day - fully utilised - 20,000 to 30,000 hours.

Machines in use 24 hours/day - 40,000 to 80,000 hours.

Machines in seasonal use - 4,000 to 8,000 hours.

Limiting loads

The axial load F_{oa} must not exceed half the basic static load rating C_{or} . Housing strengths must also be considered as a limiting factor - see page 21.

Table 18.1

Basic bearing insert	f_0
1017	13,1
1020	13,1
1025	13,9
1030	13,8
1035	13,8
1040	14,0
1045	14,1
1050	14,4
1055	14,3
1060	14,3
1065	14,4
1070	14,4
1075	14,7
1080	14,6
1085	14,7
1090	14,5
3095	13,6

Table 18.2

$\frac{f_0 F_a}{C_{or}}$	Y
0,172	2,30
0,345	1,99
0,689	1,71
1,03	1,55
1,38	1,45
2,07	1,31
3,45	1,15
5,17	1,04
6,89	1,00

Example 1

What nominal life can be obtained from NP55 with a steady radial load $F_r = 3900N$ at a speed of 1500 rev/min? The dynamic load rating C_r of the unit from page 25 is 43500N. Since the bearing is not subject to axial load the equivalent load $P_r = F_r$ according to the formula on page 17. Therefore applying the service factor of 1.2 for a steady load (given on page 17)

$$P_r = F_r \times 1.2 = 3900 \times 1.2 = 4680N.$$

From page 17,

$$L_{10} \text{ life in hours} = \left(\frac{C_r}{P_r}\right)^3 \times \frac{10^6}{n \times 60}$$

$$= \left(\frac{43500}{4680}\right)^3 \times \frac{10^6}{1500 \times 60}$$

$$= 8923 \text{ hours}$$

Alternatively, using the loading ratio tables on page 20 an approximate life can be obtained by locating the nearest $\frac{C_r}{P_r}$ value in the appropriate rev/min column.

Therefore $\frac{C_r}{P_r} = \frac{43500}{4680} = 9.29$

Under the 1500 rev/min column the nearest $\frac{C_r}{P_r}$ value is 9.65 which gives an approximate life of 10000 hours.

Example 2

With a radial load $F_r = 2940N$ and an axial load $F_a = 1470N$ at 300 rev/min with moderate shock present, what nominal L_{10} life can be obtained from unit reference SF40?

The dynamic radial load rating (C_r) of the unit from page 39 is 29100N and the static load rating (C_{or}) is 17900N.

Since the bearing is subject to radial and axial loads we have to establish the equivalent load P_r according to page 17.

First, we establish the value of $\frac{f_0 F_a}{C_{or}}$.

$$\frac{f_0 F_a}{C_{or}} = \frac{14,0 \times 1470}{17900} = 1,15$$

Using this value, from table 18.2 we establish a value for $Y = 1,52$ by interpolation. From page 17 we then calculate the value of P_r .

$$P_r = 2940N$$

or

$$P_r = 0,56 (2940) + 1,52 (1470) = 3881N$$

Using the greater value of P_r and applying an application factor of 1,7 (page 17) for moderate shock loads then:

$$P_r = 3881 \times 1,7 = 6598N$$

From page 17:

$$L_{10} \text{ life hours} = \left(\frac{C_r}{P_r}\right)^3 \times \frac{10^6}{60n}$$

$$= \left(\frac{29100}{6598}\right)^3 \times \frac{10^6}{60 \times 300}$$

$$= 4766 \text{ hours}$$

Alternatively, using the loading ratio tables on page 20, an approximate life can be obtained by locating the nearest C_r/P_r value in the appropriate rev/min column.

Therefore, $C_r/P_r = 29100/6598 = 4.41$.

Under the 300 rev/min column page 20 the nearest value is 4.48 which gives an approximate life of 5000 hours.

Housing strength

To check the housing strength for the above example when the axial load $F_a = 1470N$ and applying an application factor of 1,7 then:

$$\text{axial load} = 1470 \times 1,7 = 2499N$$

From page 21 we see that the maximum axial loads for the above unit are:

- 0,45 C_{or} in one direction, and
- 0,25 C_{or} in the opposite direction.

Calculating these two maximum axial loads that may be applied to housing:

$$0,45 \times 17900 = 8055N$$

$$0,25 \times 17900 = 4475N$$

From the above it can be seen that the housing will support the axial load of 2499N in either direction.

Therefore, the unit above is satisfactory for the loading conditions stated.

Note It is advisable to shoulder the shaft for high axial loads.

Life estimation for ball bearings for different $\frac{C_r}{P_r}$ ratios and speeds

L ₁₀ life (hours)	Speed: rev/min								
	25	50	100	150	200	300	500	750	1000
100					1.06	1.22	1.45	1.65	1.82
500		1.14	1.45	1.65	1.82	2.08	2.47	2.82	3.11
1000	1.14	1.44	1.82	2.08	2.29	2.62	3.11	3.56	3.91
1500	1.31	1.65	2.08	2.38	2.62	3.00	3.56	4.07	4.48
2000	1.45	1.82	2.29	2.62	2.88	3.30	3.91	4.48	4.93
3000	1.65	2.08	2.62	3.00	3.30	3.78	4.48	5.13	5.65
5000	1.96	2.47	3.11	3.56	3.91	4.48	5.32	6.08	6.70
7500	2.24	2.82	3.56	4.07	4.48	5.13	6.08	6.96	7.66
10000	2.47	3.11	3.91	4.48	4.93	5.65	6.70	7.66	8.43
19500	2.82	3.56	4.48	5.13	5.65	6.46	7.66	8.77	9.65
20000	3.11	3.91	4.93	5.65	6.21	7.11	8.43	9.65	10.6
30000	3.56	4.48	5.65	6.46	7.11	8.14	9.65	11.1	12.2
40000	3.91	4.93	6.21	7.11	7.81	8.96	10.6	12.2	13.4
60000	4.48	5.65	7.11	8.14	8.96	10.3	12.2	13.9	15.3
80000	4.93	6.21	7.81	8.96	9.83	11.3	13.4	15.3	16.8

L ₁₀ life (hours)	Speed: rev/min							
	1500	2000	3000	4000	5000	6000	8000	10000
100	2.08	2.29	2.62	2.88	3.11	3.30	3.63	3.91
500	3.56	3.91	4.48	4.93	5.32	5.65	6.21	6.69
1000	4.48	4.93	5.65	6.21	6.70	7.11	7.81	8.43
1500	5.13	5.65	6.46	7.11	7.65	8.15	8.96	9.65
2000	5.65	6.21	7.11	7.81	8.43	8.96	9.83	10.6
3000	6.46	7.11	8.14	8.96	9.65	10.3	11.3	12.2
5000	7.66	8.43	9.65	10.6	11.5	12.2	13.4	14.4
7500	8.77	9.65	11.1	12.2	13.1	13.9	15.3	16.5
10000	9.65	10.6	12.2	13.4	14.5	15.3	16.8	18.2
19500	11.1	12.2	13.9	15.3	16.5	17.5	19.3	20.8
20000	12.2	13.4	15.3	16.8	18.2	19.3	21.2	22.9
30000	13.9	15.3	17.5	19.3	20.8	22.1	24.3	26.2
40000	15.3	16.8	19.3	21.2	22.9	24.3	26.7	28.8
60000	17.5	19.3	22.1	24.3	26.2	27.8	30.7	33.0
80000	19.3	21.2	24.3	26.7	28.8	30.7	33.7	36.3

Maximum recommended steady housing loads

The maximum loads shown below are given as a proportion of the static load rating (C_{or}) of the bearing insert. Where the value of the axial load exceeds the set screw axial holding load listed on page 14, a shoulder on the shaft must be provided against the face of the inner ring.

For shock load conditions additional safety factors must be applied.

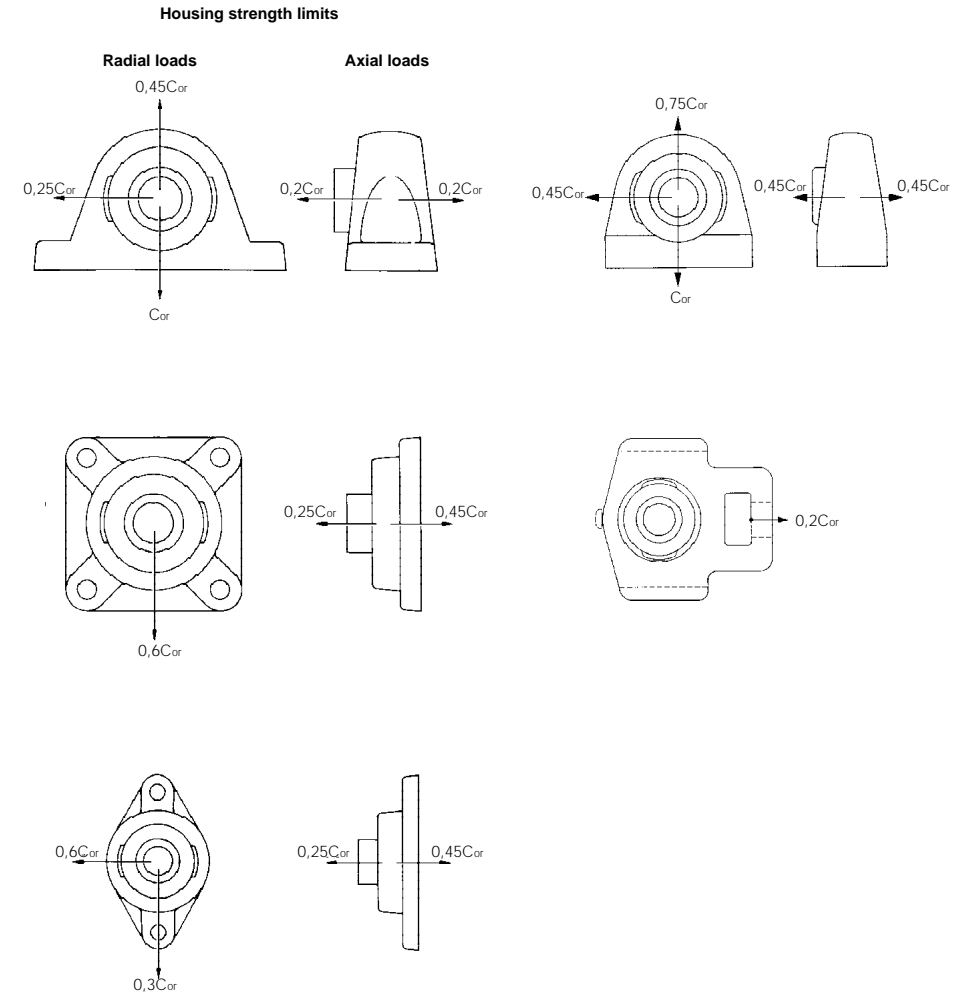

Refer to RHP for other types giving application details

Tolerances and speeds

Inner ring bore tolerances - Set screw and eccentric collar types

Nominal bore diameter d				Tolerance			
mm above	incl.	inch above	incl.	0,001mm units high	low	0-0001 inch units high	low
10	18	0-3937	0-7087	+15	0	+6	0
18	31,750	0-7087	1-2500	+18	0	+7	0
31,750	50,800	1-2500	2-0000	+21	0	+8	0
50,800	80	2-0000	3-1496	+24	0	+9	0
80	100	3-1496	3-9370	+28	0	+11	0

The inner ring tolerances above do not apply to Disc Harrow type bearings shown on pages 94-101.

Inner ring bore tolerances - series 1726200 - 2RS and 1726300 - 2RS.

Nominal bore diameter d				Tolerance			
mm above	incl.	inch above	incl.	0,001mm units high	low	0-0001 inch units high	low
10	18	0-3937	0-7087	0	-8	0	-3
18	30	0-7087	1-1811	0	-10	0	-4
30	50	1-1811	1-9685	0	-12	0	-5

Outer ring outside diameter tolerances

Nominal outside diameter D		Tolerance			
mm above	incl.	0,001mm units high	low	0-0001 inch units high	low
30	50	0	-11	0	-4
50	80	0	-13	0	-5
80	120	0	-15	0	-6
120	150	0	-18	0	-7
150	180	0	-25	0	-10
180	250	0	-30	0	-12

Housing tolerances for parallel outside diameter inserts - series 1100, 1100DEC, 1300 and 1300EC

Nominal housing bore	Stationary outer ring				Rotating outer ring			
	Housing tolerance ISO H7		Housing tolerance ISO N7		Housing tolerance ISO H7		Housing tolerance ISO N7	
mm	0,001mm units high	low	0-0001 inch units high	low	0,001mm units high	low	0-0001 inch units high	low
40	+25	0	+10	0	-8	-33	-3	-13
47	+25	0	+10	0	-8	-33	-3	-13
52	+30	0	+12	0	-9	-39	-4	-15
62	+30	0	+12	0	-9	-39	-4	-15
72	+30	0	+12	0	-9	-39	-4	-15
80	+30	0	+12	0	-9	-39	-4	-15
85	+35	0	+14	0	-10	-45	-4	-18
90	+35	0	+14	0	-10	-45	-4	-18
100	+35	0	+14	0	-10	-45	-4	-18
110	+35	0	+14	0	-10	-45	-4	-18
120	+35	0	+14	0	-10	-45	-4	-18
125	+40	0	+16	0	-12	-52	-5	-20
130	+40	0	+16	0	-12	-52	-5	-20
140	+40	0	+16	0	-12	-52	-5	-20
150	+40	0	+16	0	-12	-52	-5	-20
160	+40	0	+16	0	-12	-52	-5	-20

Tolerances and speeds

Shaft tolerances and permissible speeds

Basic bearing insert	Shaft diameter		High loads - high speeds				Normal applications				Light loads - low speeds						
			Max. speed rev/ min	Shaft tolerance ISO h6 0-001mm units high	low	0-0001inch units high	low	Max. speed rev/ min	Shaft tolerance ISO h7 0,001mm units high	low	0-0001inch units high	low	Max. speed rev/ min	Shaft tolerance speed ISO h9 0,001mm units high	low	0-0001inch units high	low
	mm	inches															
1017	12-17	1/2-11/16	8800	0	-11	0	-4	5000	0	-18	0	-7	2000	0	-43	0	-17
1020	20	3/4	7450	0	-13	0	-5	4200	0	-21	0	-8	1700	0	-52	0	-20
1025	25	13/16-1	6250	0	-13	0	-5	3600	0	-21	0	-8	1350	0	-52	0	-20
1030	25-30	7/8-11/4	5300	0	-13	0	-5	3100	0	-21	0	-8	1100	0	-52	0	-20
1035	30-35	11/8-17/16	4500	0	-16	0	-6	2700	0	-25	0	-10	900	0	-62	0	-24
1040	35-40	13/8-19/16	4000	0	-16	0	-6	2400	0	-25	0	-10	750	0	-62	0	-24
1045	40-45	11/2-13/4	3700	0	-16	0	-6	2200	0	-25	0	-10	600	0	-62	0	-24
1050	45-50	15/8-2	3400	0	-16	0	-6	1950	0	-25	0	-10	500	0	-62	0	-24
1055	50-55	17/8-23/16	3100	0	-19	0	-7	1800	0	-30	0	-12	450	0	-74	0	-29
1060	55-60	21/8-27/16	2800	0	-19	0	-7	1600	0	-30	0	-12	400	0	-74	0	-29
1065	65	21/2	2600	0	-19	0	-7	1500	0	-30	0	-12	350	0	-74	0	-29
1070	60-70	27/16-211/16	2450	0	-19	0	-7	1400	0	-30	0	-12	300	0	-74	0	-29
1075	65-75	211/16-215/16	2300	0	-19	0	-7	1300	0	-30	0	-12	280	0	-74	0	-29
1080	75-80	215/16-31/4	2150	0	-19	0	-7	1200	0	-30	0	-12	250	0	-74	0	-29
1085	80-85	33/16-37/16	2000	0	-22	0	-9	1100	0	-35	0	-14	220	0	-87	0	-34
1090	85-90	37/16-31/2	1900	0	-22	0	-9	1050	0	-35	0	-14	200	0	-87	0	-34
3095	95-100	315/16-4	1600	0	-22	0	-9	1000	0	-35	0	-14	180	0	-87	0	-34

For most applications the standard set screw lock is more than satisfactory.

Whenever eccentric collar units are used it is recommended that the high loads column of shaft tolerances be adopted.

Whenever taper adapter sleeve locking arrangements are used the light loads column of shaft tolerances can be adopted.

When operating conditions are very severe, for example, in case of heavy vibration or shock, a light interference fit may be required between the shaft and bearing bore diameter.

Housing tolerances for bearing units - series FC, MFC, SLC and MSC

Bearing unit reference	Housing tolerance	
	Stationary housing	Rotating housing
SLC MSC	ISO H7	ISO N7
FC MFC	ISO H7	

NP SERIES

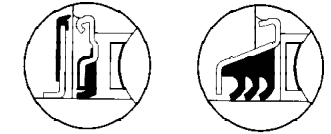
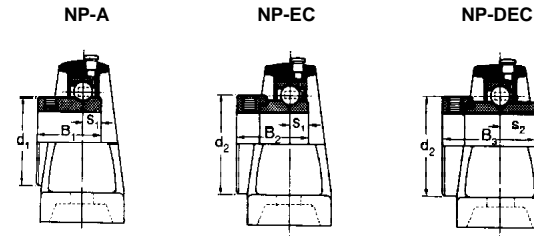
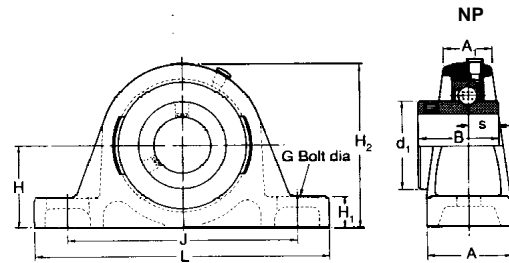

Bearing inserts with flinger seals shown on pages 91 and 92 can be fitted into these housings. The unit reference has the suffix 'FS', e.g. NP40FS.

Triple seal bearing inserts shown on pages 88 to 90 can be fitted into these housings. The unit reference has a prefix 'T', e.g. TNP25.

Shaft diameter	RHP designation				Basic bearing insert	Casting group	Dimensions				bolt centres			
							L	H	H ₁	H ₂	J _{max}	J _{min}		
mm inches					mm inches									
12 15 16 17 1/2 5/8	NP12 NP15 NP16 NP17 NP1 1/2 NP 5/8				1017	1	126,5 4.980	30,20 1.189	14,2 -559	57,2 2.252	100,5 3.957	85,5 3.366		
20 3/4	NP20 NP 3/4	NP20A NP 3/4A	NP20EC NP 3/4EC	NP20DEC NP 3/4DEC	1020	2	127,0 5.000	33,30 1.311	14,0 -551	65,2 2.567	100,5 3.957	88,5 3.484		
25 7/8 15/16 1	NP25 NP 7/8 NP 15/16 NP1	NP25A NP1A	NP25EC NP 7/8EC NP 15/16EC NP1EC	NP25DEC NP 7/8DEC NP 15/16DEC NP1DEC	1025	3	139,0 5.472	36,50 1.437	16,0 -630	71,0 2.795	112,7 4.437	96,8 3.811		
30 1 1/8 1 3/16 1 1/4	NP30 NP 1 1/8 NP 1 3/16 NP 1 1/4	NP30A NP 1 1/8A NP 1 3/16A NP 1 1/4A	NP30EC NP 1 1/8EC NP 1 3/16EC NP 1 1/4EC	NP30DEC NP 1 1/8DEC NP 1 3/16DEC NP 1 1/4DEC	1030	4	160,5 6.319	42,90 1.689	17,7 -697	82,7 3.256	129,5 5.098	108,5 4.272		
35 1 1/4 1 3/8 1 7/16	NP35 NP 1 1/4 NP 1 3/8 NP 1 7/16	NP35A NP 1 1/4A	NP35EC NP 1 1/4EC NP 1 3/8EC NP 1 7/16EC	NP35DEC NP 1 1/4DEC NP 1 3/8DEC NP 1 7/16DEC	1035	5	166,0 6.535	47,60 1.874	17,5 -689	93,0 3.661	136,5 5.374	121,5 4.783		
40 1 1/2	NP40 NP 1 1/2	NP40A NP 1 1/2A	NP40EC NP 1 1/2EC	NP40DEC NP 1 1/2DEC	1040	6	180,5 7.106	49,20 1.937	18,5 -728	98,5 3.878	148,0 5.827	127,0 5.000		
45 1 5/8 1 11/16 1 3/4	NP45 NP 1 5/8 NP 1 11/16 NP 1 3/4	NP45A NP 1 5/8A NP 1 11/16A NP 1 3/4A	NP45EC NP 1 5/8EC NP 1 11/16EC NP 1 3/4EC	NP45DEC NP 1 5/8DEC NP 1 11/16DEC NP 1 3/4DEC	1045	7	190,5 7.500	54,00 2.126	20,0 -787	108,0 4.252	154,5 6.083	140,5 5.531		
50 1 7/8 1 15/16 2	NP50 NP 1 7/8 NP 1 15/16 NP2R	NP50A NP 1 7/8A NP 1 15/16A	NP50EC NP 1 7/8EC NP 1 15/16EC	NP50DEC NP 1 7/8DEC NP 1 15/16DEC	1050	8	206,0 8.110	57,20 2.252	21,0 -827	115,2 4.535	163,0 6.417	154,0 6.063		
55 2 2 1/8 2 3/16	NP55 NP2 NP 2 1/8 NP 2 3/16			NP55DEC NP2DEC NP 2 1/8DEC NP 2 3/16DEC	1055	9	219,5 8.641	63,50 2.500	24,8 -976	129,5 5.098	178,5 7.028	162,5 6.398		
60 2 1/4 2 3/8 2 7/16	NP60 NP 2 1/4 NP 2 3/8 NP 2 7/16			NP60DEC NP 2 1/4DEC NP 2 3/8DEC NP 2 7/16DEC	1060	10	240,0 9.449	69,90 2.752	26,3 1.035	142,3 5.602	201,0 7.913	176,0 6.929		

G	A	A ₁	B	B ₁	B ₂	B ₃	s	s ₁	s ₂	d ₁	d ₂	ISO load ratings		Rec. max. speed	Mass (approx.)
												dynamic C _r	static C _{0r}		
mm inches												newtons lbf	newtons lbf	rev/min	kg lb
10 3/8	30,5 1.201	20,5 -807	27,38 1.078	- -	28,54 1.124	- -	11,55 -455	6,55 -258	- -	24,21 -953	28,58 1.125	9550 2150	4760 1070	7000	0,5 1.0
10 3/8	32,5 1.280	22,5 -886	30,96 1.219	25,77 1.015	30,92 1.217	43,62 1.717	12,75 -502	7,56 -298	17,12 -674	28,50 1.122	33,30 1.311	12800 2880	6580 1480	6700	0,6 1.4
10 3/8	36,5 1.437	24,5 -965	34,11 1.343	27,35 1.077	30,92 1.217	44,40 1.748	14,32 -564	7,56 -298	17,49 -689	34,01 1.339	38,10 1.500	14000 3150	7880 1770	6250	0,7 1.5
12 1/2	41,5 1.634	27,5 1.083	38,10 1.500	31,21 1.229	35,68 1.405	48,42 1.906	15,93 -627	9,04 -356	18,32 -721	40,00 1.575	44,45 1.750	19500 4380	11300 2540	5300	1,3 2.9
12 1/2	44,5 1.752	30,5 1.201	42,88 1.688	34,90 1.374	38,88 1.531	51,18 2.015	17,53 -690	9,55 -376	18,89 -744	46,69 1.838	55,58 2.188	25700 5780	15300 3440	4500	1,7 3.8
12 1/2	51,0 2.008	34,5 1.358	49,23 1.938	41,18 1.621	43,64 1.718	56,34 2.218	19,10 -752	11,05 -435	21,46 -845	52,70 2.075	60,30 2.374	29100 6540	17900 4020	4000	2,1 4.6
12 1/2	54,0 2.126	35,0 1.378	49,23 1.938	41,18 1.621	43,64 1.718	56,34 2.218	19,10 -752	11,05 -435	21,46 -845	57,30 2.256	63,50 2.500	32500 7310	20500 4610	3700	2,8 6.2
16 5/8	55,0 2.165	36,0 1.417	51,59 2.031	43,54 1.714	43,64 1.718	62,70 2.469	19,10 -752	11,05 -435	24,65 -970	62,20 2.449	69,85 2.750	35000 7870	23200 5220	3400	3,2 7.1
16 5/8	60,0 2.362	39,5 1.555	55,55 2.187	- -	- -	71,44 2.813	22,28 -877	- -	27,82 1.095	68,81 2.709	76,20 3.000	43500 9780	29200 6560	3100	4,0 8.8
16 5/8	70,0 2.756	46,0 1.811	65,07 2.562	- -	- -	77,82 3.064	25,45 1.002	- -	31,02 1.221	75,34 2.966	84,12 3.312	52500 11800	35900 8070	2800	5,9 13.1

Please check availability

NP SERIES
(continued)

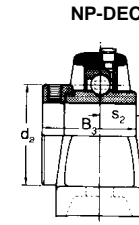
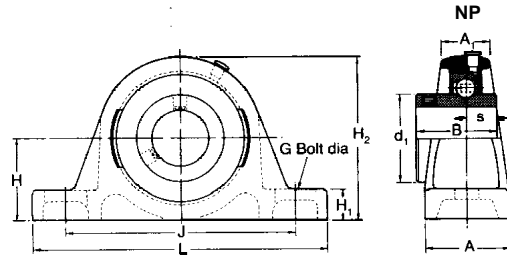

Shaft diameter		RHP designation	Basic bearing insert	Casting group	Dimensions				bolt centres		
					L	H	H ₁	H ₂	J max	J min	
mm	inches			mm inches							
65	2 1/2	NP65 NP2 1/2	NP65DEC NP2 1/2 DEC	1065	10/65	250,0 9.843	69,90 2.752	26,3 1.035	144,3 5.681	205,0 8.071	176,0 6.929
70	2 11/16	NP70 NP2 11/16	NP70DEC	1070	11	266,0 10.472	79,4 3.126	30,2 1.189	156,0 6.142	220,0 8.661	200,0 7.874
75	2 3/4 2 7/8 2 15/16 3	NP75 NP2 3/4 NP7 8 NP2 15/16 NP3	NP75DEC	1075	12	275,0 10.827	82,6 3.252	28,0 1.102	164,0 6.457	228,0 8.976	206,0 8.110
80	3	NP80 NP3L		1080	13	291,0 11.457	88,9 3.500	30,0 1.181	174,0 6.850	241,0 9.488	214,0 8.425
85	3 1/4 3 3/8	NP85 NP3 1/4 NP3 3/8		1085	14	310,0 12.205	95,2 3.748	32,0 1.260	187,0 7.362	262,0 10.315	232,0 9.134
90	3 7/16 3 1/2	NP90 NP3 7/16 NP3 1/2		1090	15	327,0 12.874	101,6 4.000	36,0 1.417	200,0 7.874	280,0 11.024	244,0 9.606

G	A	A ₁	B	B ₁	B ₂	B ₃	s	s ₁	s ₂	d ₁	d ₂	ISO load ratings		Rec. max. speed	Mass (approx.)	
												dynamic C _r	static C _{0r}			
mm	inches											newtons lbf	newtons lbf	rev/ min	kg lb	
16 5/8	70,0 2.756	45,0 1.772	65,07 2.562	-	-	-	77,82 3.064	25,45 1.002	-	31,02 1.221	82,40 3.244	87,33 3.438	57500 12930	40000 8990	2600	5,9 13.1
24 7/8	72,0 2.835	47,0 1.850	74,63 2.938	-	-	-	85,36 3.361	30,23 1.190	-	34,19 1.346	87,00 3.425	96,82 3.812	62000 13940	44000 9890	2450	8,0 17.6
24 7/8	74,0 2.913	48,0 1.890	77,77 3.062	-	-	-	91,72 3.611	33,37 1.314	-	37,37 1.471	92,00 3.622	101,60 4.000	66000 14840	49300 11080	2300	9,0 19.8
24 7/8	78,0 3.071	56,0 2.205	82,55 3.250	-	-	-	33,37 1.314	-	-	-	98,50 3.878	-	72500 16300	53000 11910	2150	9,7 21.4
24 7/8	83,0 3.268	56,0 2.205	85,72 3.375	-	-	-	34,18 1.346	-	-	-	106,02 4.174	-	83500 18770	63800 14340	2000	11,8 26.0
24 7/8	88,0 3.465	62,0 2.441	96,04 3.781	-	-	-	39,73 1.564	-	-	-	111,66 4.396	-	96000 21580	71500 17870	1900	14,7 32.4

NP1000-K SERIES

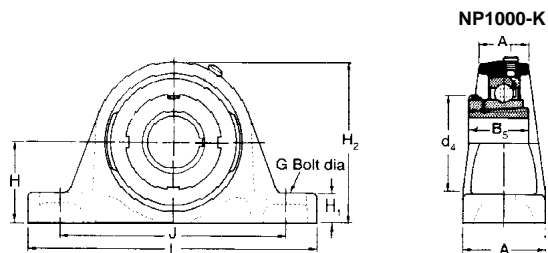

Shaft diameter	RHP designation complete unit	sleeve, nut & lockwasher assembly only	unit without sleeve, nut & lockwasher	Basic bearing insert	Casting group	Dimensions					
						L	H	H ₁	H ₂	bolt centres	
mm	inches					mm					
						inches					
20	NP1025-20K NP1025-3/4K	H305 HE305-3/4	NP1025K	1025	3	139,0 5-472	36,50 1-437	16,0 -630	71,0 2-795	112,7 4-437	96,8 3-811
25	NP1030-25K NP1030-15/16K NP1030-1K	H306 HE306-15/16 HE306-1	NP1030K	1030	4	160,5 6-319	42,90 1-689	17,7 -697	82,7 3-256	129,5 5-098	108,5 4-272
30	NP1035-30K NP1035-11/8K NP1035-13/16K	H307 HE307-11/8 HE307-13/16	NP1035K	1035	5	166,0 6-535	47,60 1-874	17,5 -689	93,0 3-661	136,5 5-374	121,5 4-783
35	NP1040-35K NP1040-11/4K NP1040-13/8K	H308 HE308-11/4 HE308-13/8	NP1040K	1040	6	180,5 7-106	49,20 1-937	18,5 -728	98,5 3-878	148,0 5-827	127,0 5-000
40	NP1045-40K NP1045-17/16K NP1045-11/2K	H309 HE309-17/16 HE309-11/2	NP1045K	1045	7	190,5 7-500	54,00 2-126	20,0 -787	108,0 4-252	154,5 6-083	140,5 5-531
45	NP1050-45K NP1050-111/16K NP1050-13/4K	H310 HE310-111/16 HE310-13/4	NP1050K	1050	8	206,0 8-110	57,20 2-252	21,0 -827	115,2 4-535	163,0 6-417	154,0 6-063
50	NP1055-50K NP1055-15/16K NP1055-2K	H311 HE311-15/16 HE311-2	NP1055K	1055	9	219,5 8-641	63,50 2-500	24,8 -976	129,5 5-098	178,5 7-028	162,5 6-398

G	A	A ₁	B ₅	d ₄	ISO load ratings		Rec. max. speed	Mass (approx.)
					dynamic C _r	static C _{0r}		
mm	inches				newtons lbf	newtons lbf	rev/min	kg lb
10	36,5	24,5	29,0	38,0	14000	7880	6250	0,7
3/8	1-437	-965	1-142	1-496	3150	1770	1500	1-5
12	41,5	27,5	31,0	45,0	19500	11300	5300	1,3
1/2	1-634	1-083	1-220	1-772	4380	2540	2900	2-9
12	44,5	30,5	35,0	52,0	25700	15300	4500	1,7
1/2	1-752	1-201	1-378	2-047	5780	3440	3900	3-8
12	51,0	34,5	36,0	58,0	29100	17900	4000	2,1
1/2	2-008	1-358	1-417	2-283	6540	4020	4500	4-6
12	54,0	35,0	39,0	65,0	32500	20500	3700	2,8
1/2	2-126	1-378	1-535	2-559	7310	4610	4200	6-2
16	55,0	36,0	42,0	70,0	35000	23200	3400	3,2
5/8	2-165	1-147	1-654	2-756	7870	5220	3900	7-1
16	60,0	39,5	45,0	75,0	43500	29200	3100	4,0
5/8	2-362	1-555	1-772	2-953	9780	6560	3500	8-8

SL SERIES

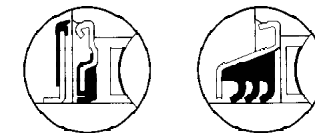
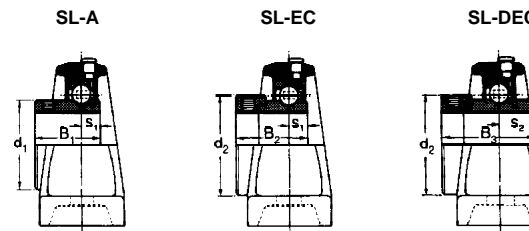
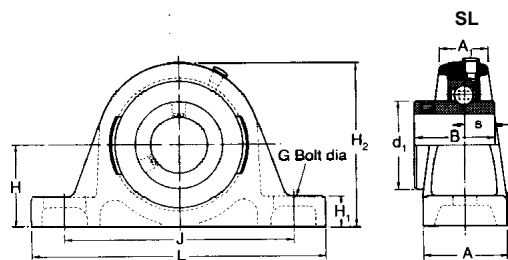

Bearing inserts with flinger seals shown on pages 91 and 92 can be fitted into these housings. The unit reference has the suffix 'FS', e.g. SL1^{1/4}FS.

Triple seal bearing inserts shown on pages 88 to 90 can be fitted into these housings. The unit reference has a prefix 'T', e.g. TSL1^{1/4}.

Shaft diameter	RHP designation		Basic bearing insert	Casting group	Dimensions					bolt centres			
					L	H	H ₁	H ₂	J max	J min			
mm	inches			mm					inches				
12		SL12	SL12EC	1017	1	119,0	26,97	11,0	54,0	91,5	85,5		
15		SL15	SL15EC			4-685	1-062	-433	2-126	3-602	3-366		
16		SL16	SL16EC										
17		SL17	SL17EC										
	1/2	SL1^{1/2}	SL1^{1/2}EC										
	5/8	SL1^{5/8}	SL1^{5/8}EC										
20		SL20	SL20A	SL20EC	SL20DEC	1020	2	126,5	31,75	12,5	63,7	100,5	88,5
		SL3/4	SL3/4A	SL3/4EC	SL3/4DEC			4-980	1-250	-492	2-508	3-957	3-484
25		SL25	SL25A	SL25EC	SL25DEC	1025	3	139,0	33,32	12,8	67,8	110,2	98,2
	7/8	SL7/8	SL7/8A	SL7/8EC	SL7/8DEC			5-472	1-312	-504	2-669	4-339	3-866
	15/16	SL1^{5/16}	SL1^{5/16}A	SL1^{5/16}EC	SL1^{5/16}DEC								
	1	SL1	SL1A	SL1EC	SL1DEC								
30		SL30	SL30A	SL30EC	SL30DEC	1030	4	161,5	39,67	14,5	79,5	130,0	109,0
	1 1/8	SL1 1/8	SL1 1/8A	SL1 1/8EC	SL1 1/8DEC			6-358	1-562	-571	3-130	5-118	4-291
	1 3/16	SL1 3/16	SL1 3/16A	SL1 3/16EC	SL1 3/16DEC								
	1 1/4	SL1 1/4R	SL1 1/4AR	SL1 1/4RECR	SL1 1/4DEC								
35		SL35	SL35A	SL35EC	SL35DEC	1035	5	166,0	46,02	16,0	91,5	136,5	121,5
	1 1/4	SL1 1/4	SL1 1/4A	SL1 1/4EC	SL1 1/4DEC			6-535	1-812	-630	3-602	5-374	4-783
	1 3/8	SL1 3/8	SL1 3/8A	SL1 3/8EC	SL1 3/8DEC								
	1 7/16	SL1 7/16	SL1 7/16A	SL1 7/16EC	SL1 7/16DEC								
40		SL40	SL40A	SL40EC	SL40DEC	1040	6	180,5	49,20	18,5	98,5	148,0	127,0
	1 1/2	SL1 1/2	SL1 1/2A	SL1 1/2EC	SL1 1/2DEC			7-106	1-937	-728	3-878	5-827	5-000
45		SL45	SL45A	SL45EC	SL45DEC	1045	7	197,5	52,37	18,4	106,4	161,5	141,5
	1 5/8	SL1 5/8	SL1 5/8A	SL1 5/8EC	SL1 5/8DEC			7-776	2-062	-724	4-189	6-358	5-571
	1 11/16	SL1 11/16	SL1 11/16A	SL1 11/16EC	SL1 11/16DEC								
	1 3/4	SL1 3/4	SL1 3/4A	SL1 3/4EC	SL1 3/4DEC								
50		SL50	SL50A	SL50EC	SL50DEC	1050	8	214,0	55,55	19,3	114,0	177,0	151,0
	1 7/8	SL1 7/8	SL1 7/8A	SL1 7/8EC	SL1 7/8DEC			8-425	2-187	-760	4-488	6-969	5-945
	1 15/16	SL1 15/16	SL1 15/16A	SL1 15/16EC	SL1 15/16DEC								
	2	SL2R											
55		SL55		SL55DEC		1055	9	219,5	61,90	23,2	128,0	178,5	162,5
	2	SL2		SL2DEC				8-641	2-437	-913	5-039	7-028	6-398
	2 1/8	SL2 1/8		SL2 1/8DEC									
	2 3/16	SL2 3/16		SL2 3/16DEC									
60		SL60		SL60DEC		1060	10	240,0	68,25	24,6	140,6	201,0	176,0
	2 1/4	SL2 1/4		SL2 1/4DEC				9-449	2-687	-969	5-535	7-913	6-929
	2 3/8	SL2 3/8		SL2 3/8DEC									
	2 7/16	SL2 7/16		SL2 7/16DEC									
65		SL65R			SL2 1/2DEC	1065	10/65	250,0	68,25	24,6	142,6	205,00	176,00
	2 1/2	SL2 1/2						9-843	2-687	-969	5-614	8-071	6-929
65		SL65		SL65DEC		1075	11	286,0	82,55	28,0	165,5	241,5	200,5
70		SL70		SL70DEC				11-260	3-250	11-024	6-516	9-508	7-894
75		SL75		SL75DEC									
	2 11/16	SL2 11/16		SL2 11/16DEC									
	2 3/4	SL2 3/4		SL2 3/4DEC									
	2 7/8	SL2 7/8		SL2 7/8DEC									
	2 15/16	SL2 15/16		SL2 15/16DEC									

G	A	A ₁	B	B ₁	B ₂	B ₃	s	s ₁	s ₂	d ₁	d ₂	ISO load ratings		Rec. max. speed	Mass (approx.)	
												dynamic C _r	static C _{or}			
mm	inches												newtons lbf	newtons lbf	rev/min	kg lb
10	30,5	20,5	27,38	-	28,54	-	11,55	6,55	-	24,21	28,58	9550	4760	7000	0,5	
3/8	1-181	-807	1-078	-	1-124	-	-455	-258	-	-953	1-125	2150	1070		1-0	
10	32,0	22,5	30,96	25,77	30,92	43,62	12,75	7,56	17,12	28,50	33,30	12800	6580	6700	0,6	
3/8	1-260	-886	1-219	1-015	1-217	1-717	-502	-298	-674	1-122	1-311	2880	1480		1-4	
10	36,0	24,5	34,11	27,35	30,92	44,40	14,32	7,56	17,49	34,01	38,10	14000	7880	6250	0,7	
3/8	1-417	-965	1-343	1-077	1-217	1-748	-564	-298	-689	1-339	1-500	3150	1770		1-5	
12	41,0	27,5	38,10	31,21	35,68	48,42	15,93	9,04	18,32	40,00	44,45	19500	11300	5300	1,3	
1/2	1-614	1-083	1-500	1-229	1-405	1-906	-627	-356	-721	1-575	1-750	4380	2540		2-9	
12	44,5	30,5	42,88	34,90	38,88	51,18	17,53	9,55	18,89	46,69	55,58	25700	15300	4500	1,7	
1/2	1-752	1-201	1-688	1-374	1-531	2-015	-690	-376	-744	1-838	2-188	5780	3440		3-8	
12	51,0	34,5	49,23	41,18	43,64	56,34	19,10	11,05	21,46	52,70	60,30	29100	17900	4000	2,1	
1/2	2-008	1-358	1-938	1-621	1-718	2-218	-752	-435	-845	2-075	2-374	6540	4020		4-6	
12	54,0	35,0	49,23	41,18	43,64	56,34	19,10	11,05	21,46	57,30	63,50	32500	20500	3700	3,0	
1/2	2-126	1-378	1-938	1-621	1-718	2-218	-752	-435	-845	2-256	2-500	7310	4610		6-7	
12	55,0	36,0	51,59	43,54	43,64	62,70	19,10	11,05	24,65	62,20	69,85	35000	23200	3400	3,4	
1/2	2-165	1-417	2-031	1-714	1-718	2-469	-752	-435	-970	2-449	2-750	7870	5220		7-6	
16	60,0	39,5	55,55	-	-	71,44	22,28	-	27,82	68,81	76,20	43500	29200	3100	4,0	
5/8	2-362	1-555	2-187	-	-	2-813	-877	-	1-095	2-709	3-000	9780	6560		8-8	
16	70,0	46,0	65,07	-	-	77,82	25,45	-	31,02	75,34	84,12	52500	35900	2800	6,1	
5/8	2-756	1-811	2-562	-	-	3-064	1-002	-	1-221	2-966	3-312	11800	8070		13-4	
16	70,0	45,0	65,07	-	-	77,82	25,45	-	31,02	82,40	87,33	57500	40000	2600	6,2	
5/8	2-756	1,772	2-562	-	-	3-064	1-002	-	1-221	3-244	3-438	12930	8990		13-7	
20	74,0	47,5	77,77	-	-	91,72	33,37	-	37,37	92,00	101,60	66000	49300	2300	11,6	
3/4	2-913	1,870	3-063	-	-	3-611	1-314	-	1-471	3-622	4-000	14840	11080		25-3	

Please check availability

MP SERIES

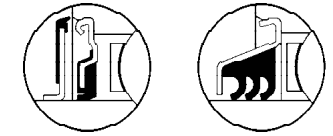
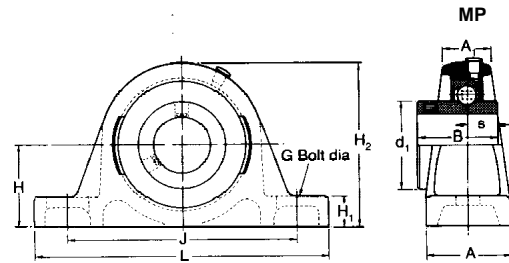

Bearing inserts with flinger seals shown on pages 91 and 92 can be fitted into these housings. The unit reference has the suffix 'FS' e.g. MP40FS.

Triple seal bearing inserts shown on pages 88 to 90 can be fitted into these housings. The unit reference has a prefix 'T', e.g. TMP40.

Shaft diameter	RHP designation	Basic bearing insert	Casting group	Dimensions							bolt centres	
				L	H	H ₁	H ₂	J max	J min	G	A	
mm inches				mm inches								
25 1	MP25 MP1	1030	1	160,5 6-319	44,45 1-750	19,3 -760	84,3 3-319	127,5 5-020	108,5 4-272	12 1/2	41,5 1-634	
30 1 3/16 1 1/4	MP30 MP13/16 MP11/4	1035	2	166,0 6-535	47,60 1-874	17,5 -689	93,0 3-661	136,5 5-374	121,5 4-783	12 1/2	44,5 1-752	
35 1 3/8 1 7/16	MP35 MP13/8 MP17/16	1040	3	203,2 8-000	53,98 2-125	23,0 -906	107,5 4-232	160,0 6-300	135,0 5-315	12 1/2	57,0 2-244	
40 1 1/2	MP40 MP11/2	1045	4	222,2 8-748	58,72 2-312	22,5 -886	116,7 4-594	172,5 6-791	145,0 5-709	16 5/8	60,0 2-362	
45 1 11/16 1 3/4	MP45 MP11 1/16 MP13/4	1050	5	222,2 8-748	58,72 2-312	22,5 -886	116,7 4-594	172,5 6-791	145,0 5-709	16 5/8	60,0 2-362	
50 1 7/8 1 15/16 2	MP50 MP17/8 MP115/16 MP2	1055	6	219,5 8-641	63,50 2-500	24,8 -976	129,5 5-098	178,5 7-028	162,5 6-398	16 5/8	60,0 2-362	
55 2 3/16 2 1/4	MP55 MP23/16	1060	7	249,5 9-823	69,85 2-750	26,2 -1031	142,2 5-598	201,0 7-913	179,0 7-047	20 3/4	69,5 2-736	
60 2 7/16 2 1/2	MP60 MP65R MP27/16 MP21/2	1070	8	266,0 10-472	76,20 3-000	27,0 -1-063	153,0 6-024	224,5 8-839	189,5 7-461	20 3/4	72,0 2-835	
65 2 11/16 2 3/4	MP65 MP70 MP21 1/16 MP23/4	1075	9	330,2 13-000	88,90 3-500	28,6 -1-126	177,8 7-000	255,6 10-063	206,0 8-110	24 1	88,9 3-500	
75 2 15/16 3	MP75 MP215/16 MP3	1080	10	330,2 13-000	88,90 3-500	31,8 -1-252	184,2 7-252	255,6 10-063	228,0 8-976	24 1	88,9 3-500	
80 3 3/16 3 1/4	MP80 MP33/16 MP3 1/4	1085	11	381,0 15-000	101,60 4-000	31,8 -1-252	203,2 8-000	317,5 12-500	260,0 10-236	24 1	101,6 4-000	
85 3 7/16 3 1/2	MP85 MP90 MP37/16 MP3 1/2	1090	12	381,0 15-000	101,60 4-000	33,3 -1-311	209,6 8-252	319,1 12-563	246,1 9-689	24 1	111,1 4-374	
95 3 15/16 4	MP95 MP100 MP315/16 MP4	3095	13	431,8 17-000	127,00 5-000	33,3 -1-311	254,0 10-000	371,5 14-626	301,6 11-874	24 1	120,6 4-748	

				ISO load ratings		Rec. max. speed	Mass (approx.)
A ₁	B	s	d ₁	dynamic C _r	static C _{0r}		
mm inches				newtons lbf	newtons lbf	rev/min	kg lb
27,5 1-083	38,10 1-500	15,93 -627	40,00 1-575	19500 4380	11300 2540	5300 2-9	1,3 2-9
30,5 1-201	42,88 1-688	17,53 -690	46,69 1-838	25700 5780	15300 3440	4500 3-8	1,7 3-8
40,5 1-594	49,23 1-938	19,10 -752	52,70 2-075	29100 6540	17900 4020	4000 6-0	2,7 6-0
39,5 1-555	49,23 1-938	19,10 -752	57,30 2-256	32500 7310	20500 4610	3700 7-1	3,2 7-1
39,5 1-555	51,59 2-031	19,10 -752	62,20 2-449	35000 7870	23200 5220	3400 7-1	3,2 7-1
39,5 1-555	55,65 2-187	22,28 -877	68,81 2-709	43500 9780	29200 6560	3100 8-8	4,0 8-8
46,0 1-811	65,07 2-562	25,45 -1-002	75,34 2-966	52500 11800	35900 8070	2800 15-6	7,1 15-6
47,0 1-850	74,63 2-938	30,23 -1-190	87,00 3-425	62000 13940	44000 9890	2450 20-5	9,3 20-5
66,7 2-626	77,7 3-062	33,37 -1-314	92,0 3-622	66000 14840	49300 11080	2300 29-5	13,4 29-5
66,7 2-626	82,55 3-250	33,37 -1-314	98,50 3-878	72500 16300	53000 11910	2150 31-6	14,3 31-6
68,3 2-689	85,72 3-375	34,18 -1-346	106,02 4-174	83500 18770	63800 14340	2000 40-2	18,2 40-2
79,4 3-126	96,04 3-781	39,73 -1-564	111,66 4-396	96000 21580	71500 16070	1900 51-6	23,4 51-6
98,4 3-874	117,48 4-625	49,27 -1-940	130,43 5-135	143000 32150	110000 24730	1600 75-8	34,4 75-8

Please check availability

MP1000-K SERIES

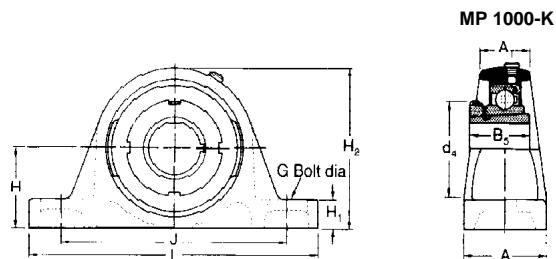

Shaft diameter	RHP designation			Basic bearing insert	Casting group	Dimensions						
	complete unit	sleeve, nut & lockwasher assembly only	unit without sleeve, nut & lockwasher			L	H	H ₁	H ₂	bolt centres		
mm	inches					mm						
						inches						
25	1 ^{5/16} 1	MP1030-25K	H306	MP1030K	1030	1	160,5	44,45	19,3	87,4	127,5	108,5
		MP1030-15/16K	HE306-15/16				6-319	1-750	-760	3-441	5-020	4-272
		MP1030-1K	HE306-1									
30	1 ^{1/8} 1 ^{3/16}	MP1035-30K	H307	MP1035K	1035	2	166,0	47,60	17,5	93,0	136,5	121,5
		MP1035-1 ^{1/8} K	HE307-1 ^{1/8}				6-535	1-874	-689	3-661	5-374	4-783
		MP1035-13/16K	HE307-13/16									
35	1 ^{1/4} 1 ^{3/8}	MP1040-35K	H308	MP1040K	1040	3	203,2	53,98	23,0	106,4	160,0	135,0
		MP1040-1 ^{1/4} K	HE308-1 ^{1/4}				8-000	2-125	-906	4-189	6-300	5-315
		MP1040-13/8K	HE308-13/8									
40	1 ^{7/16} 1 ^{1/2}	MP1045-40K	H309	MP1045K	1045	4	222,2	58,72	22,5	116,7	172,5	145,0
		MP1045-17/16K	HE309-17/16				8-748	2-312	-864	4-594	6-791	5-709
		MP1045-1 ^{1/2} K	HE309-1 ^{1/2}									
45	1 ^{11/16} 1 ^{3/4}	MP1050-45K	H310	MP1050K	1050	5	222,2	58,72	22,5	116,7	172,5	145,0
		MP1050-1 ^{11/16} K	HE310-1 ^{11/16}				8-748	2-312	-864	4-594	6-791	5-709
		MP1050-13/4K	HE310-13/4									
50	1 ^{15/16} 2	MP1055-50K	H311	MP1055K	1055	6	219,5	63,50	24,8	129,5	178,5	162,5
		MP1055-1 ^{15/16} K	HE311-1 ^{15/16}				8-641	2-500	-976	5-098	7-028	6-398
		MP1055-2K	HE311-2									

G	A	A ₁	B _s	d ₄	ISO load ratings		Rec. max. speed	Mass (approx.)
					dynamic C _r	static C _{0r}		
mm	inches				newtons lbf	newtons lbf	rev/min	kg lb
12	41,5	27,5	31,0	45,0	19500	11300	5300	1,3
	1/2	1-634	1-083	1-220	1-772	4380		
12	44,5	30,5	35,0	52,0	25700	15300	4500	1,7
	1/2	1-752	1-201	1-378	2-047	5780		
12	57,0	40,5	36,0	58,0	29100	17900	4000	2,2
	1/2	2-244	1-594	1-417	2-283	6540		
16	60,0	39,5	39,0	65,0	32500	20500	3700	3,2
	5/8	2-362	1-555	1-535	2-559	7310		
16	60,0	39,5	42,0	70,0	35000	23200	3400	3,2
	5/8	2-362	1-555	1-654	2-756	7870		
16	60,0	39,5	45,0	75,00	43500	29200	3100	4,0
	5/8	2-362	1-555	1-772	2-953	9780		

SNP SERIES (metric thread)
CNP SERIES (UNC thread)**

**These units are identical to SNP series except for thread details

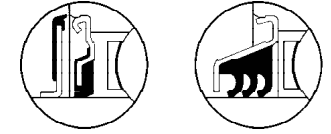
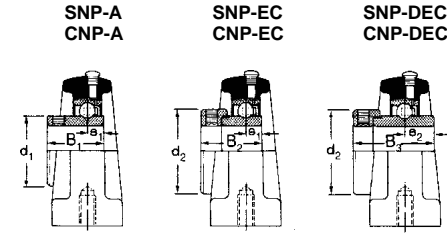
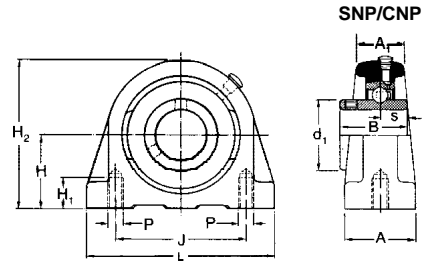

Bearing inserts with flinger seals shown on pages 91 and 92 can be fitted into these housings. The unit reference has the suffix 'FS', e.g. SNP25FS.

Triple seal bearing inserts shown on pages 88 to 90 can be fitted into these housings. The unit reference has a prefix 'T', e.g. TSNP25.

Shaft diameter	RHP designation				Basic bearing group insert	Casting group	Dimensions																		
							L	H	H ₁	H ₂	J														
mm inches							mm inches																		
20	3/4	SNP20 SNP ³ / ₄	SNP20A SNP ³ / ₄ A	SNP20EC SNP ³ / ₄ EC	SNP20DEC SNP ³ / ₄ DEC	1020 2	65,0 2-559	33,30 1-311	13,5 -531	65,8 2-591	50,8 2-000														
25	7/8 15/16 1	SNP25 SNP ⁷ / ₈ SNP ¹⁵ / ₁₆ SNP1	SNP25A SNP ⁷ / ₈ A SNP ¹⁵ / ₁₆ A SNP1A	SNP25EC SNP ⁷ / ₈ EC SNP ¹⁵ / ₁₆ EC SNP1EC	SNP25DEC SNP ⁷ / ₈ DEC SNP ¹⁵ / ₁₆ DEC SNP1DEC	1025 3	70,0 2-756	36,50 1-437	13,5 -531	71,5 2-815	50,8 2-000														
30	1 1/8 1 3/16 1 1/4	SNP30 SNP ¹ / ₈ SNP ³ / ₁₆ SNP1 1/4R	SNP30A SNP ¹ / ₈ A SNP ³ / ₁₆ A SNP1 1/4AR	SNP30EC SNP ¹ / ₈ EC SNP ³ / ₁₆ EC SNP1 1/4ECR	SNP30DEC SNP ¹ / ₈ DEC SNP ³ / ₁₆ DEC SNP1 1/4DEC	1030 4	96,0 3-780	42,90 1-689	16,5 -650	83,9 3-303	76,2 3-000														
35	1 1/4 1 3/8 1 7/16	SNP35 SNP ¹ / ₄ SNP ³ / ₈ SNP1 7/16	SNP35A SNP ¹ / ₄ A SNP ³ / ₈ A SNP1 7/16A	SNP35EC SNP ¹ / ₄ EC SNP ³ / ₈ EC SNP1 7/16EC	SNP35DEC SNP ¹ / ₄ DEC SNP ³ / ₈ DEC SNP1 7/16DEC	1035 5	110,0 4-331	47,60 1-874	19,5 -768	95,6 3-764	82,6 3-252														
40	1 1/2	SNP40 SNP1 1/2	SNP40A SNP1 1/2A	SNP40EC SNP1 1/2EC	SNP40DEC SNP1 1/2DEC	1040 6	118,0 4-646	49,20 1-937	19,5 -768	101,7 4-004	88,9 3-500														
45	1 5/8 1 11/16 1 3/4	SNP45 SNP ⁵ / ₈ SNP ¹¹ / ₁₆ SNP1 3/4	SNP45A SNP ⁵ / ₈ A SNP ¹¹ / ₁₆ A SNP1 3/4A	SNP45EC SNP ⁵ / ₈ EC SNP ¹¹ / ₁₆ EC SNP1 3/4EC	SNP45DEC SNP ⁵ / ₈ DEC SNP ¹¹ / ₁₆ DEC SNP1 3/4DEC	1045 7	127,0 5-000	54,00 2-126	19,5 -768	110,0 4-331	95,3 3-752														
50	1 7/8 1 15/16 2	SNP50 SNP ⁷ / ₈ SNP ¹⁵ / ₁₆ SNP2R	SNP50A SNP ⁷ / ₈ A SNP ¹⁵ / ₁₆ A	SNP50EC SNP ⁷ / ₈ EC SNP ¹⁵ / ₁₆ EC	SNP50DEC SNP ⁷ / ₈ DEC SNP ¹⁵ / ₁₆ DEC	1050 8	135,0 5-315	57,2 2-252	23,5 -925	115,0 4-528	101,6 4-000														
55	2 2 1/8 2 3/16	SNP55 SNP2 SNP2 1/8 SNP2 3/16	SNP55A SNP2A SNP2 1/8A SNP2 3/16A	SNP55EC SNP2EC SNP2 1/8EC SNP2 3/16EC	SNP55DEC SNP2DEC SNP2 1/8DEC SNP2 3/16DEC	1055 9	154,0 6-063	63,50 2-500	26,5 1-043	130,0 5-118	118,0 4-646														
60	2 1/4 2 3/8 2 7/16	SNP60 SNP2 1/4 SNP2 3/8 SNP2 7/16	SNP60A SNP2 1/4A SNP2 3/8A SNP2 7/16A	SNP60EC SNP2 1/4EC SNP2 3/8EC SNP2 7/16EC	SNP60DEC SNP2 1/4DEC SNP2 3/8DEC SNP2 7/16DEC	1060 10	154,0 6-063	69,90 2-752	26,5 1-043	141,5 5-571	118,0 4-646														

SNP	CNP	A	A ₁	B	B ₁	B ₂	B ₃	s	s ₁	s ₂	d ₁	d ₂	ISO load ratings		Rec. max. speed	Mass (approx.)	
													dynamic C _r	static C _{0r}			
mm inches														newtons lbf	newtons lbf	rev/min	kg lb
M8x1,25	3/8-16UNC	32,0 1-260	22,5 -886	30,96 1-219	25,77 1-015	30,92 1-217	43,62 1-717	12,75 -502	7,56 -298	17,12 -674	28,50 1-122	33,30 1-311	12800 2880	6580 1480	6,700 1480	0,9 2,0	
M10x1,50	3/8-16UNC	36,0 1-417	25,0 -984	34,11 1-343	27,35 1-077	30,92 1-217	44,40 1-748	14,32 -564	7,57 -298	17,49 -689	34,01 1-339	38,10 1-500	14000 3150	7880 1770	6250 1370	1,2 2,6	
M10x1,50	7/16-14UNC	40,0 1-575	26,5 1-043	38,10 1-500	31,21 1-229	35,68 1-405	48,42 1-906	15,93 -627	9,04 -356	18,32 -721	40,00 1-575	44,45 1-750	19500 4380	11300 2540	5300 1170	1,8 4,0	
M10x1,50	1/2-13UNC	45,0 1-772	30,0 1-181	42,88 1-688	34,90 1-374	38,88 1-531	51,18 2-015	17,53 -690	9,55 -376	18,89 -744	46,69 1-838	55,58 2-188	25700 5780	15300 3440	4500 980	2,4 5,3	
M12x1,75	1/2-13UNC	47,0 1-850	32,0 1-260	49,23 1-938	41,18 1-621	43,64 1-718	56,34 2-218	19,10 -752	11,05 -435	21,46 -845	52,70 2-075	60,30 2-374	29100 6540	17900 4020	4000 880	2,8 6,2	
M12x1,75	1/2-13UNC	48,0 1-890	33,0 1-299	49,23 1-938	41,18 1-621	43,64 1-718	56,34 2-218	19,10 -752	11,05 -435	21,46 -845	57,30 2-256	63,50 2-500	32500 7310	20500 4610	3700 810	3,5 7,8	
M16x2,0	5/8-11UNC	54,0 2-126	34,0 1-339	51,59 2-031	43,54 1-714	43,64 1-718	62,70 2-469	19,10 -752	11,05 -435	24,65 -970	62,20 2-449	69,85 2-750	35000 7870	23200 5220	3400 750	3,3 7,3	
M16x2,00	5/8-11UNC	60,0 2-362	41,5 1-639	55,55 2-187	-	-	71,44 2-813	22,28 -877	-	27,82 1-095	68,81 2-709	76,20 3-000	43500 9780	29200 6560	3100 680	4,0 8,8	
M16x2,00	5/8-11UNC	60,0 2-362	41,5 1-639	65,07 2-562	-	-	77,82 3-064	25,45 -1-002	-	31,02 1-221	75,34 2-966	84,12 3-312	52500 11800	35900 8070	2800 610	4,6 10,1	

SF SERIES

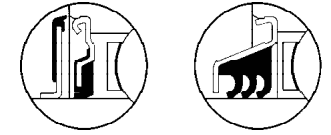
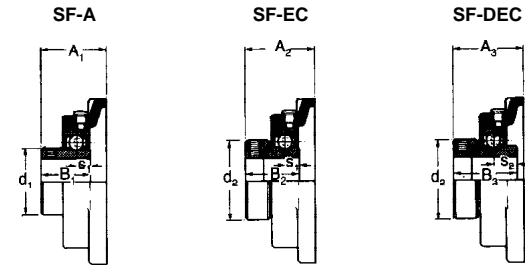
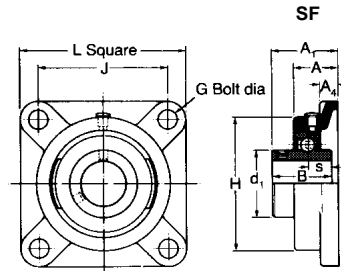

Bearing inserts with flinger seals shown on pages 91 and 92 can be fitted into these housings. The unit reference has the suffix 'FS', e.g. SF7/8FS.

Triple seal bearing inserts shown on pages 88 to 90 can be fitted into these housings. The unit reference has a prefix 'T', e.g. TSF7/8.

Shaft diameter		RHP designation		Basic bearing insert	Casting group	Dimensions					
mm	inches					L	H	J	G	A	A1
12		SF12	SF12EC	1017	1	76.2	52.50	54.00	10	24.6	32.87
15		SF15	SF15EC			3.000	2.067	2.126	3/8	.969	1.294
16		SF16	SF16EC								
17		SF17	SF17EC								
1/2	5/8	SF17/2	SF17/2EC								
		SF5/8	SF5/8EC								
20	3/4	SF20	SF20EC	1020	2	85.7	60.3	63.5	10	27.8	37.26
		SF3/4	SF3/4EC			3.374	2.374	2.500	3/8	1.094	1.467
25		SF25	SF25EC	1025	3	95.3	68.0	70.00	10	28.6	38.84
	7/8	SF7/8	SF7/8EC			3.752	2.677	2.756	7/16	1.126	1.529
	15/16	SF15/16	SF15/16EC								
1		SF1	SF1DEC								
30	1 1/8	SF30	SF30EC	1030	4	108.0	82.6	82.50	10	29.8	42.21
	1 3/16	SF11/8	SF11/8EC			4.252	3.252	3.248	7/16	1.173	1.662
	1 1/4	SF13/16	SF13/16EC								
		SF11/4AR	SF11/4AR								
35	1 1/4	SF35	SF35EC	1035	5	117.5	95.3	92.00	12	31.4	46.41
	1 3/8	SF11/4	SF11/4EC			4.626	3.752	3.622	1/2	1.236	1.827
	1 7/16	SF13/8	SF13/8EC								
		SF17/16	SF17/16EC								
40	1 1/2	SF40	SF40EC	1040	6	130.2	101.6	101.50	12	34.9	54.18
		SF11/2	SF11/2EC			5.126	4.000	3.996	1/2	1.374	2.133
45		SF45	SF45EC	1045	7	136.5	111.1	105.00	16	35.3	54.18
	15/8	SF15/8	SF15/8EC			5.374	4.374	4.134	5/8	1.390	2.133
	111/16	SF111/16	SF111/16EC								
	1 3/4	SF13/4	SF13/4EC								
50	1 7/8	SF50	SF50EC	1050	8	142.9	115.9	111.00	16	39.7	60.53
	1 15/16	SF17/8	SF17/8EC			5.626	4.563	4.370	5/8	1.563	2.383
	2	SF15/16	SF15/16EC								
		SF2R									
55	2	SF55	SF55EC	1055	9	161.9	127.0	130.00	16	43.7	64.31
	2 1/8	SF2	SF2DEC			6.374	5.000	5.118	5/8	1.720	2.532
	2 3/16	SF21/8	SF21/8DEC								
		SF23/16	SF23/16DEC								
60	2 1/4	SF60	SF60EC	1060	10	174.5	138.1	143.00	16	47.6	73.69
	2 3/8	SF21/4	SF21/4DEC			6.870	5.437	5.630	5/8	1.874	2.901
	2 7/16	SF23/8	SF23/8DEC								
		SF27/16	SF27/16DEC								
65	2 1/2	SF65R	SF65RDEC	1065	10/65	174.5	149.5	143.00	16	47.6	73.69
		SF21/2	SF21/2DEC			6.870	5.886	5.630	5/8	1.874	2.901
65		SF65	SF65DEC	1070	11	187.5	155.5	149.22	16	47.6	77.72
70		SF70	SF70DEC			7.382	6.122	5.875	5/8	1.874	3.060
	2 5/8	SF25/8	SF25/8DEC								
	2 11/16	SF211/16	SF211/16DEC								
75	2 3/4	SF75	SF75DEC	1075	12	196.5	158.5	152.40	20	51.3	80.90
	2 7/8	SF23/4	SF23/4DEC			7.736	6.240	6.000	3/4	2.020	3.185
	2 15/16	SF27/8	SF27/8DEC								
	3	SF215/16	SF215/16DEC								
		SF3									

A2		A3		A4		B		B1		B2		B3		s		s1		s2		d1		d2		ISO load ratings		Rec. max. speed		Mass (approx.)	
mm	inches	mm	inches	mm	inches	mm	inches	mm	inches	mm	inches	mm	inches	mm	inches	mm	inches	mm	inches	mm	inches	mm	inches	newtons	newtons	rev/min	kg	lb	
39.01	-	9.5	27.38	-	28.54	-	11.55	6.55	-	24.21	28.58	9550	4760	7000	0.5														
1.536	-	.374	1.078	-	1.124	-	.455	.258	-	.953	1.125	2150	1070	1070	1.1														
42.42	45.54	11.1	30.96	25.77	30.92	43.62	12.75	7.56	17.12	28.50	33.30	12800	6580	6700	0.7														
1.670	1.793	.437	1.219	1.015	1.217	1.717	.502	.298	.674	1.122	1.311	2880	1480	1480	1.5														
42.42	45.95	11.1	34.11	27.35	30.92	44.40	14.32	7.56	17.49	34.01	38.10	14000	7880	6250	1.0														
1.670	1.809	.437	1.343	1.077	1.217	1.748	.564	.298	.689	1.339	1.500	3150	1770	1770	2.3														
46.66	50.9	12.7	38.10	31.21	35.68	48.42	15.93	9.04	18.32	40.00	44.45	19500	11300	5300	1.3														
1.837	1.972	.500	1.500	1.229	1.405	1.906	.627	.356	.721	1.575	1.750	4380	2540	2540	2.9														
50.34	53.31	12.7	42.88	34.90	38.88	51.18	17.53	9.55	18.89	46.69	55.58	25700	15300	4500	1.7														
1.982	2.099	.500	1.688	1.374	1.531	2.015	.690	.376	.744	1.838	2.188	5780	3440	3440	3.7														
56.62	58.90	12.7	49.23	41.18	43.64	56.34	19.10	11.05	21.46	52.70	60.30	29100	17900	4000	2.2														
2.229	2.319	.500	1.938	1.621	1.718	2.218	.752	.435	.845	2.075	2.374	6540	4020	4020	4.9														
56.62	58.90	14.3	49.23	41.18	43.64	56.34	19.10	11.05	21.46	57.30	63.50	32500	20500	3700	2.6														
2.229	2.319	.563	1.938	1.621	1.718	2.218	.752	.435	.845	2.256	2.500	7310	4610	4610	5.7														
60.60	66.07	14.3	51.59	43.54	43.64	62.70	19.10	11.05	24.65	62.20	69.85	35000	23200	3400	2.8														
2.386	2.601	.563	2.031	1.714	1.718	2.469	.752	.435	.970	2.449	2.750	7870	5220	5220	6.2														
-	74.57	17.5	55.55	-	-	71.44	22.28	-	27.82	68.81	76.20	43500	29200	3100	4.0														
-	2.936	.689	2.187	-	-	2.813	.877	-	1.095	2.709	3.000	9780	6560	6560	8.8														
-	80.77	17.5	65.07	-	-	77.82	25.45	-	31.02	75.34	84.12	52500	35900	2800	4.7														
-	3.180	.689	2.562	-	-	3.064	1.002	-	1.221	2.966	3.312	11800	8070	8070	10.3														
-	80.77	18.0	65.07	-	-	77.82	25.45	-	31.02	82.40	87.33	57500	40000	2600	2.7														
-	3.180	.709	2.562	-	-	3.064	1.002	-	1.221	3.244	3.438	12930	8990	8990	10.3														
-	84.86	18.0	74.63	-	-	85.36	30.23	-	34.19	87.00	96.82	62000	44000	2450	6.8														
-	3.341	.709	2.938	-	-	3.361	1.190	-	1.346	3.425	3.812	13940	9890	9890	15.0														
-	91.21	23.0	77.77	-	-	91.72	33.37	-	37.37	92.00	101.60	66000	49300	2300	8.6														
-	3.591	.906	3.062	-	-	3.611	1.314	-	1.471	3.622	4.000	14840	11080	11080	19.0														

Please check availability

MSF SERIES

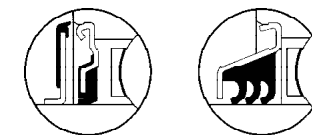
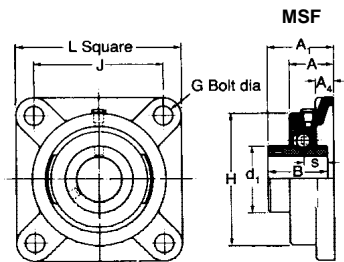

Bearing inserts with flinger seals shown on pages 91 and 92 can be fitted into these housings. The unit reference has the suffix 'FS' e.g. MSF35FS.

Triple seal bearing inserts shown on pages 88 to 90 can be fitted into these housings. The unit reference has a prefix 'T', e.g. TMSF35.

Shaft diameter		RHP designation	Basic bearing insert	Casting group	Dimensions									
mm	inches				L	H	J	G	A	A ₁	A ₄	B	S	
25	1	MSF25 MSF1	1030	1	108,0 4-252	82,6 3-252	82,50 3-248	10 7/16	29,8 1-173	42,21 1-662	12,7 -500	38,10 1-500		
30	1 3/16 1 1/4	MSF30 MSF1 3/16 MSF1 1/4	1035	2	117,5 4-626	95,3 3-752	92,0 3-622	12 1/2	31,4 1-236	46,41 1-827	12,7 -500	42,88 1-688		
35	1 3/8 1 7/16	MSF35 MSF1 3/8 MSF1 7/16	1040	3	130,2 5-126	101,6 4-000	101,50 3-996	12 1/2	34,9 1-374	54,18 2-133	12,7 -500	49,23 1-938		
40	1 1/2	MSF40 MSF1 1/2	1045	4	136,5 5-374	111,1 4-374	105,00 4-134	16 5/8	35,3 1-390	54,18 2-133	14,3 -563	49,23 1-938		
45	1 11/16 1 3/4	MSF45 MSF1 11/16 MSF1 3/4	1050	5	142,9 5-626	115,9 4-563	111,00 4-370	16 5/8	39,7 1-563	60,53 2-383	14,3 -563	51,59 2-031		
50	1 7/8 1 15/16 2	MSF50 MSF1 7/8 MSF1 15/16 MSF2	1055	6	161,9 6-374	127,0 5-000	130,00 5-118	16 5/8	43,7 1-720	64,31 2-532	17,5 -689	55,55 2-187		
55	2 3/16 2 1/4	MSF55 MSF2 3/16	1060	7	174,5 6-870	138,1 5-437	143,00 5-630	16 5/8	47,6 1-874	73,69 2-901	17,5 -689	65,07 2-562		
60	2 7/16 2 1/2	MSF60 MSF2 7/16 MSF2 1/2	1070	8	187,55 7-382	155,5 6-122	149,22 5-875	16 5/8	47,6 1-874	77,2 3-060	18,0 -709	74,63 2-938		
65 70	2 11/16 2 3/4	MSF65 MSF70 MSF2 11/16 MSF2 3/4	1075	9	196,5 7-736	158,5 6-240	152,40 6-000	20 3/4	51,3 2-020	80,90 3-185	23,0 -960	77,77 3-062		
75	2 15/16 3	MSF75 MSF2 15/16 MSF3	1080	10	196,5 7-736	173,5 6-831	152,40 6-000	20 3/4	55,0 2-165	88,87 3-499	23,0 -906	82,55 3-250		
80	3 3/16 3 1/4	MSF80 MSF3 3/16 MSF3 1/4	1085	11	213,5 8-406	184,0 7-244	171,45 6-750	20 3/4	54,3 2-138	89,64 3-529	26,0 1-024	85,72 3-375		
85 90	3 7/16 3 1/2	MSF85 MSF90 MSF3 7/16 MSF3 1/2	1090	12	381,0 8-406	101,60 7-736	171,45 6-750	20 3/4	61,7 2-429	100,76 3-967	26 1-024	96,04 3-781		
95 100	3 15/16 4	MSF95 MSF100 MSF3 15/16 MSF4	3095	13	267,5 10-531	235,5 9-272	211,12 8-312	24 1	83,5 3-287	126,95 4-998	32,0 1-260	117,48 4-625		

		ISO load ratings		Rec. max. speed	Mass (approx.)		
s	d ₁	dynamic C _r	static C _{0r}				
mm inches		newtons lbf	newtons lbf	rev/min	kg lb		
25	1	15,93 -627	40,00 1-575	19500 4380	11300 2540	5300	1,3 2-9
30	1 3/16 1 1/4	17,53 -690	46,69 1-838	25700 5780	15300 3440	4500	1,7 3-7
35	1 3/8 1 7/16	19,10 -752	52,70 2-075	29100 6540	17900 4020	4000	2,2 4-9
40	1 1/2	19,10 -752	57,30 2-256	32500 7310	20500 4610	3700	2,6 5-7
45	1 11/16 1 3/4	19,10 -752	62,20 2-449	35000 7870	23200 5220	3400	2,8 6-2
50	1 7/8 1 15/16 2	22,28 -877	68,81 2-709	43500 9780	29200 6560	3100	4,0 8-8
55	2 3/16 2 1/4	25,45 1-002	75,34 2-966	52500 11800	35900 8070	2800	4,7 10-3
60	2 7/16 2 1/2	30,23 1-190	87,00 3-425	62000 13940	44000 9890	2450	6,8 15-0
65 70	2 11/16 2 3/4	33,37 1-314	92,00 3-622	66000 14840	49300 11080	2300	8,6 19-0
75	2 15/16 3	33,37 1-314	98,50 3-878	72500 16300	53000 11910	2150	9,3 20-6
80	3 3/16 3 1/4	34,18 1-346	106,02 4-174	83500 18770	63800 14340	2000	11,1 24-5
85 90	3 7/16 3 1/2	39,73 1-564	111,66 4-396	96000 21580	71500 16070	1900	13,2 29-1
95 100	3 15/16 4	49,27 1-940	130,43 5-135	143000 32150	110000 24730	1600	24,7 54-5

Please check availability

MSF1000-K SERIES

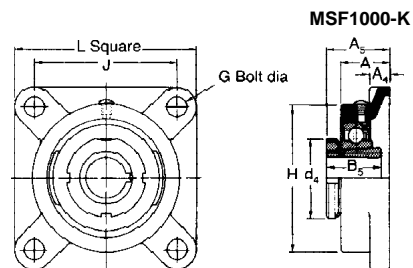

Shaft diameter	RHP designation complete unit	sleeve, nut & lockwasher assembly only	unit without sleeve, nut & lockwasher	Basic bearing insert	Casting group	Dimensions					
						L	H	J	G	A	A4
mm	inches					mm inches					
20	MSF1025-20K MSF1025-3/4K	H305 HE3053/4	MSF1025K	1025	SF3	95,3 3-752	68,0 2-677	70,0 2-756	10 7/16	28,6 1-126	11,1 -437
25	MSF1030-25K MSF1030-15/16K MSF1030-1K	H306 HE306-15/16 HE306-1	MP1030K	1030	1	108,0 4-252	82,6 3-252	82,50 3-248	10 7/16	29,8 1-173	12,7 -500
30	MSF1035-30K MSF1035-11/8K MSF1035-13/16K	H307 HE307-11/8 HE307-13/16	MP1035K	1035	2	117,5 4-626	95,3 3-752	92,00 3-622	12 1/2	31,4 1-236	12,7 -500
35	MSF1040-35K MSF1040-11/4K MSF1040-13/8K	H308 HE308-11/4 HE308-13/8	MP1040K	1040	3	130,2 5-126	101,6 4-000	101,50 3-996	12 1/2	34,9 1-374	12,7 -500
40	MSF1045-40K MSF1045-17/16K MSF1045-11/2K	H309 HE309-17/16 HE309-11/2	MP1045K	1045	4	136,5 5-374	111,1 4-374	105,00 4-134	16 5/8	35,3 1-390	14,3 -563
45	MSF1050-45K MSF1050-111/16K MSF1050-13/4K	H310 HE310-111/16 HE310-13/4	MP1050K	1050	5	142,9 5-626	115,9 4-563	111,00 4-370	16 5/8	39,7 1-563	14,3 -563
50	MSF1055-50K MSF1055-115/16K MSF1055-2K	H311 HE311-115/16 HE311-2	MP1055K	1055	6	161,9 6-374	127,00 5-000	130,00 5-118	16 5/8	43,7 1-720	17,5 -689

A5	B5	d4	ISO load ratings		Rec. max. speed	Mass (approx.)
			dynamic Cr	static Cor		
mm inches			newtons lbf	newtons lbf	rev/ min	kg lb
36,5 1-437	29,0 1-142	38,0 1-496	14000 3150	7880 1770	6250	1,0 2-3
38,0 1-496	31,0 1-220	45,0 1-772	19500 4380	11300 2540	5300	1,3 2-9
40,5 1-594	35,0 1-378	52,0 2-047	25700 5780	15300 3440	4500	1,7 3-7
45,0 1-772	36,0 1-417	58,0 2-283	29100 6540	17900 4020	4000	2,2 4-9
46,5 1-831	39,0 1-535	65,0 2-559	32500 7310	20500 4610	3700	2,6 5-7
52,0 2-047	42,0 1-654	70,0 2-756	35000 7870	23200 5220	3400	2,8 6-2
55,5 2-185	45,0 1-772	75,0 2-953	43500 9780	29200 6560	3100	4,0 8-8

SFT SERIES (ISO)

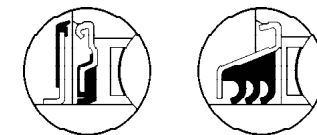
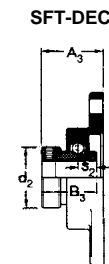
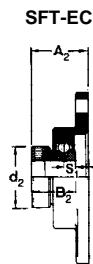
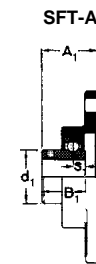
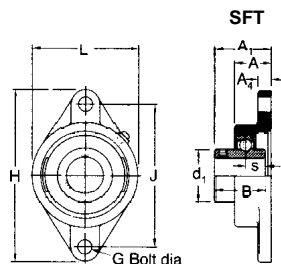

Bearing inserts with flinger seals shown on pages 91 and 92 can be fitted into these housings. The unit reference has the suffix 'FS', e.g. SFT1FS.

Triple seal bearing inserts shown on pages 88 to 90 can be fitted into these housings. The unit reference has a prefix 'T', e.g. TSFT1

Shaft diameter	RHP designation	Basic bearing insert	Casting group	Dimensions					A	A1														
				L	H	J	G	A																
mm	inches																							
		mm																						
		inches																						
12	SFT12	SFT12EC	1017	1	52,5	98,5	76,50	10	24,6	32,87														
15	SFT15	SFT15EC			2,067	3,878	3,012	3/8	.969	1,294														
16	SFT16	SFT16EC																						
17	SFT17	SFT17EC																						
1/2	SFT1/2	SFT1/2EC																						
5/8	SFT5/8	SFT5/8EC																						
20	SFT20	SFT20A	SFT20EC	SFT20DEC	1020	2	60,3	111,9	90,00	10	27,8	37,26												
3/4	SFT3/4	SFT3/4A	SFT3/4EC	SFT3/4DEC			2,374	4,406	3,543	3/8	1,094	1,467												
25	SFT25	SFT25A	SFT25EC	SFT25DEC	1025	3	70,0	125,5	99,00	10	28,6	38,84												
7/8	SFT7/8	SFT7/8A	SFT7/8EC	SFT7/8DEC			2,756	4,941	3,898	7/16	1,126	1,529												
15/16	SFT15/16	SFT15/16A	SFT15/16EC	SFT15/16DEC																				
1	SFT1	SFT1A	SFT1EC	SFT1DEC																				
30	SFT30	SFT30A	SFT30EC	SFT30DEC	1030	4	82,6	141,3	116,50	10	29,8	42,21												
1 1/8	SFT1 1/8	SFT1 1/8A	SFT1 1/8EC	SFT1 1/8DEC			3,252	5,563	4,687	7/16	1,173	1,662												
1 3/16	SFT1 3/16	SFT1 3/16A	SFT1 3/16EC	SFT1 3/16DEC																				
1 1/4	SFT1 1/4	SFT1 1/4A	SFT1 1/4EC	SFT1 1/4DEC																				
35	SFT35	SFT35A	SFT35EC	SFT35DEC	1035	5	95,5	155,5	130,00	12	31,4	46,41												
1 1/4	SFT1 1/4	SFT1 1/4A	SFT1 1/4EC	SFT1 1/4DEC			3,760	6,122	5,118	1/2	1,236	1,827												
1 3/8	SFT1 3/8	SFT1 3/8A	SFT1 3/8EC	SFT1 3/8 DEC																				
1 7/16	SFT1 7/16	SFT1 7/16A	SFT1 7/16EC	SFT1 7/16DEC																				
40	SFT40	SFT40A	SFT40EC	SFT40DEC	1040	6	101,6	171,4	143,50	12	34,9	54,18												
1 1/2	SFT1 1/2	SFT1 1/2A	SFT1 1/2EC	SFT1 1/2DEC			4,000	6,748	5,650	1/2	1,374	2,133												
45	SFT45	SFT45A	SFT45EC	SFT45DEC	1045	7	111,1	179,4	148,50	16	35,3	54,18												
1 5/8	SFT1 5/8	SFT1 5/8A	SFT1 5/8EC	SFT1 5/8DEC			4,374	7,063	5,846	5/8	1,390	2,133												
1 11/16	SFT1 11/16	SFT1 11/16A	SFT1 11/16EC	SFT1 11/16DEC																				
1 3/4	SFT1 3/4	SFT1 3/4A	SFT1 3/4EC	SFT1 3/4DEC																				
50	SFT50	SFT50A	SFT50EC	SFT50DEC	1050	8	115,9	188,9	157,00	16	39,7	60,53												
1 7/8	SFT1 7/8	SFT1 7/8A	SFT1 7/8EC	SFT1 7/8DEC			4,563	7,437	6,181	5/8	1,563	2,283												
1 15/16	SFT1 15/16	SFT1 15/16A	SFT1 15/16EC	SFT1 15/16DEC																				
2	SFT2R																							
55	SFT55		SFT55DEC	1055	9	127,0	215,9	184,00	16	43,7	64,31													
2 1/8	SFT2 1/8	SFT2 1/8A	SFT2 1/8EC	SFT2 1/8DEC			5,000	8,500	7,244	5/8	1,720	2,532												
2 3/16	SFT2 3/16	SFT2 3/16A	SFT2 3/16EC	SFT2 3/16DEC																				
60	SFT60		SFT60DEC	1060	10	138,1	235,0	202,00	16	47,6	73,69													
2 1/4	SFT2 1/4	SFT2 1/4A	SFT2 1/4EC	SFT2 1/4DEC			5,437	9,252	7,953	5/8	1,874	2,901												
2 3/8	SFT2 3/8	SFT2 3/8A	SFT2 3/8EC	SFT2 3/8DEC																				
2 7/16	SFT2 7/16	SFT2 7/16A	SFT2 7/16EC	SFT2 7/16DEC																				

A2	A3	A4	B	B1	B2	B3	s	s1	s2	d1	d2	ISO load ratings		Rec. max. speed	Mass (approx.)
												dynamic	static	rev/	kg
												Cr	Cor	min	lb
												newtons	newtons	lb/	lb
												lbf	lbf	min	lb
39,01	-	9,5	27,38	-	28,54	-	11,55	6,55	-	24,21	28,58	9550	4760	7000	0,4
1,536	-	.374	1,078	-	1,124	-	.455	.258	-	.953	1,125	2150	1070		0,9
42,42	45,54	11,1	30,96	25,77	30,92	43,62	12,75	7,56	17,12	28,50	33,30	12800	6580	6700	0,6
1,670	1,793	.437	1,219	1,015	1,217	1,717	.502	.298	.674	1,122	1,311	2880	1480		1,3
42,42	45,95	11,1	34,11	27,35	30,92	44,40	14,32	7,56	17,49	34,01	38,10	14000	7880	6250	0,9
1,670	1,809	.437	1,343	1,077	1,217	1,748	.564	.298	.689	1,339	1,500	3150	1770		2,0
46,66	50,09	12,7	38,10	31,21	35,68	48,42	15,93	9,04	18,32	40,00	44,45	19500	11300	5300	1,1
1,837	1,972	.500	1,500	1,229	1,405	1,906	.762	.365	.721	1,575	1,750	4380	2540		2,5
50,34	53,31	12,7	42,88	34,90	38,88	51,18	17,53	9,55	18,89	46,69	55,58	25700	15300	4500	1,4
1,982	2,099	.500	1,688	1,374	1,531	2,015	.690	.376	.744	1,838	2,188	5780	3440		3,0
56,62	58,90	12,7	49,23	41,18	43,64	56,34	19,10	11,05	21,46	52,70	60,30	29100	17900	4000	1,9
2,229	2,319	.500	1,938	1,621	1,718	2,218	.752	.435	.845	2,075	2,374	6540	4020		4,1
56,62	58,90	14,3	49,23	41,18	43,64	56,34	19,10	11,05	21,46	57,30	63,50	32500	20500	3700	2,2
2,229	2,319	.563	1,938	1,621	1,718	2,218	.752	.435	.845	2,256	2,500	7310	4610		4,9
60,60	66,07	14,3	51,59	43,54	43,64	62,70	19,10	11,05	24,65	62,20	69,85	35000	23200	3400	2,5
2,386	2,601	.563	2,031	1,714	1,718	2,469	.752	.435	.970	2,449	2,750	7870	5220		5,4
-	74,57	17,5	55,55	-	-	71,44	22,28	-	27,82	68,81	76,20	43500	29200	3100	3,5
-	2,936	.689	2,187	-	-	2,813	.877	-	1,095	2,709	3,000	9780	6560		7,8
-	80,77	17,5	65,07	-	-	77,82	25,45	-	31,02	75,34	84,12	52500	35900	2800	4,3
-	3,180	.689	2,562	-	-	3,064	1,002	-	1,221	2,966	3,312	11800	8070		9,5

Please check availability

MSFT SERIES

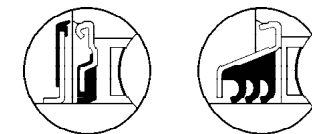
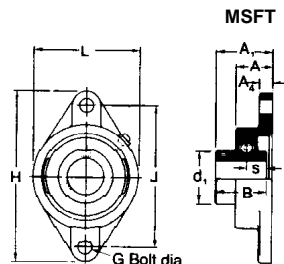

Bearing inserts with flinger seals shown on pages 91 and 92 can be fitted into these housings. The unit reference has the suffix 'FS' e.g. MSFT1 1/2 FS.

Triple seal bearing inserts shown on pages 88 to 90 can be fitted into these housings. The unit reference has a prefix 'T', e.g. TMSFT1 1/2.

Shaft diameter		RHP designation	Basic bearing insert	Casting group	Dimensions							
mm	inches				L	H	J	G	A	A ₁	A ₄	B
		mm inches										
25	1	MSFT25 MSFT1	1030	1	82,6 3.252	141,3 5.563	116,50 4.587	10 7/16	29,8 1.173	42,21 1.662	12,7 -500	38,10 1.500
30	1 3/16 1 1/4	MSFT30 MSFT1 3/16 MSFT1 1/4	1035	2	95,5 3.760	155,5 6.122	130,00 5.118	12 1/2	31,4 1.236	46,41 1.827	12,7 -500	42,88 1.688
35	1 3/8 1 7/16	MSFT35 MSFT1 3/8 MSFT1 7/16	1040	3	101,6 4.000	171,4 6.748	143,50 5.650	12 1/2	34,9 1.374	54,18 2.133	12,7 -500	49,23 1.938
40	1 1/2	MSFT40 MSFT1 1/2	1045	4	111,1 4.374	179,4 7.063	148,50 5.846	16 5/8	35,3 1.390	54,18 2.133	14,3 -563	49,23 1.938
45	1 11/16 1 3/4	MSFT45 MSFT1 11/16 MSFT1 3/4	1050	5	115,9 4.563	188,9 7.437	157,00 6.181	16 5/8	39,7 1.563	60,53 2.383	14,3 -563	51,59 2.031
50	1 7/8 1 15/16 2	MSFT50 MSFT1 7/8 MSFT1 15/16 MSFT2	1055	6	127,0 5.000	215,9 8.500	184,00 7.244	16 5/8	43,7 1.720	64,31 2.532	17,5 -689	55,55 2.187
55	2 3/16	MSFT55 MSFT2 3/16	1060	7	138,1 5.437	235,0 9.252	202,00 7.953	16 5/8	47,6 1.874	73,69 2.901	17,5 -689	65,07 2.562

s	d ₁	ISO load ratings		Rec. max. speed	Mass (approx.)
		dynamic C _r	static C _{0r}	rev/ min	kg lb
		newtons lbf	newtons lbf		
15,93 -627	40,00 1.575	19500 4380	11300 2540	5300	1,1 2.5
17,53 -690	46,69 1.838	25700 5780	15300 3440	4500	1,4 3.0
19,10 -752	52,70 2.075	29100 6540	17900 4020	4000	1,9 4.1
19,10 -752	57,30 2.256	32500 7310	20500 4610	3700	2,2 4.9
19,10 -752	62,20 2.449	35000 7870	23200 5220	3400	2,5 5.4
22,28 -877	68,81 2.709	43500 9780	29200 6560	3100	3,5 7.8
25,45 1.002	75,34 2.966	52500 11800	35900 8070	2800	4,3 9.5

MSFT1000-K SERIES

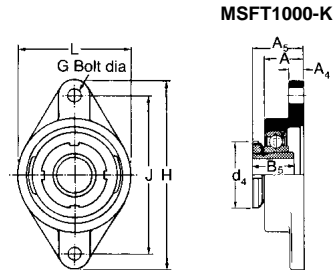

Shaft diameter	RHP designation			Basic bearing insert	Casting group	Dimensions					
	complete unit	sleeve, nut & lockwasher assembly only	unit without sleeve, nut & lockwasher			L	H	J	G	A	A ₄
mm inches				mm inches							
20 3/4	MSFT1025-20K MSFT1025-3/4K	H305 HE3053/4	MSFT1025K	1025	SFT3	68,3 2-689	123,8 4-874	99,0 3-898	10 7/16	28,6 1-126	11,1 -437
25 15/16 1	MSFT1030-25K MSFT1030-15/16K MSFT1030-1K	H306 HE306-15/16 HE306-1	MSFT1030K	1030	1	82,6 3-252	141,3 5-563	116,50 4-587	10 7/16	29,8 1-173	12,7 -500
30 1 1/8 1 3/16	MSFT1035-30K MSFT1035-1 1/8K MSFT1035-1 3/16K	H307 HE307-1 1/8 HE307-1 3/16	MSFT1035K	1035	2	95,5 3-760	155,5 6-122	130,00 5-118	12 1/2	31,4 1-236	12,7 -500
35 1 1/4 1 3/8	MSFT1040-35K MSFT1040-1 1/4K MSFT1040-1 3/8K	H308 HE308-1 1/4 HE308-1 3/8	MSFT1040K	1040	3	101,6 4-000	171,4 6-748	143,50 5-650	12 1/2	34,9 1-374	12,7 -500
40 1 7/16 1 1/2	MSFT1045-40K MSFT1045-1 7/16K MSFT1045-1 1/2K	H309 HE309-1 7/16 HE309-1 1/2	MSFT1045K	1045	4	111,1 4-374	179,4 7-063	148,50 5-846	16 5/8	35,3 1-390	14,3 -563
45 1 11/16 1 3/4	MSFT1050-45K MSFT1050-1 11/16K MSFT1050-1 3/4K	H310 HE310-1 11/16 HE310-1 3/4	MSFT1050K	1050	5	115,9 4-563	188,9 7-437	157,00 6-181	16 5/8	39,7 1-563	14,3 -563
50 1 15/16 2	MSFT1055-50K MSFT1055-1 15/16K MSFT1055-2K	H311 HE311-1 15/16 HE311-2	MSFT1055K	1055	6	127,0 5-000	215,9 8-500	184,00 7-244	16 5/8	43,7 1-720	17,5 -689

A ₅	B ₅	d ₄	ISO load ratings		Rec. max. speed	Mass (approx.)
			dynamic C _r	static C _{0r}		
mm inches	mm inches	mm inches	newtons lbf	newtons lbf	rev/min	kg lb
36,5 1-437	29,0 1-142	39,0 1-496	14000 3150	7880 1770	6250	0,9 2-0
38,0 1-496	31,0 1-220	45,0 1-772	19500 4380	11300 2540	5300	1,1 2-5
40,5 1-594	35,0 1-378	52,0 2-047	25700 5780	15300 3440	4500	1,4 3-0
45,0 1-772	36,0 1-417	58,0 2-283	29100 6540	17900 4020	4000	1,9 4-1
46,5 1-831	39,0 1-535	65,0 2-559	32500 7310	20500 4610	3700	2,2 4-9
52,0 2-047	42,0 1-654	70,0 2-756	35000 7870	23200 5220	3400	2,5 5-4
55,5 2-185	45,0 1-772	75,0 2-953	43500 9780	29200 6560	3100	3,5 7-8

LFTC SERIES

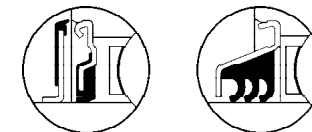
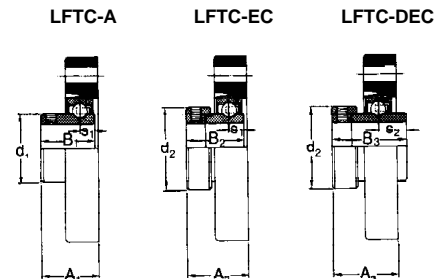
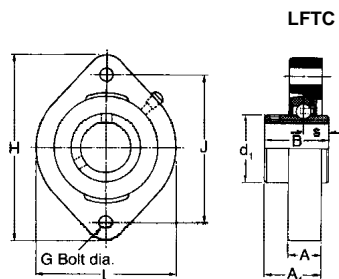

Bearing inserts with flinger seals shown on pages 91 and 92 can be fitted into these housings. The unit reference has the suffix 'FS', e.g. LFTC7/8FS.

Triple seal bearing inserts shown on pages 88 to 90 can be fitted into these housings. The unit reference has a prefix 'T', e.g. TLFTC7/8

Shaft diameter	RHP designation				Basic bearing insert	Casting group	Dimensions					
							L	H	J	G	A	A1
mm	inches											
		mm inches										
12		LFTC12		LFTC12EC	1017	1	58,5	81,0	63,5	6,0	15,0	24,27
15		LFTC15		LFTC15EC			2-303	3-189	2-500	1/4	-590	0-956
16		LFTC16		LFTC16EC								
17		LFTC17		LFTC17EC								
	1/2	LFTC1/2		LFTC1/2EC								
	5/8	LFTC5/8		LFTC5/8EC								
20		LFTC20	LFTC20A	LFTC20EC	1020	2	66,5	90,5	71,5	8,0	17,0	27,76
	3/4	LFTC3/4	LFTC3/4A	LFTC3/4EC			2-618	3-563	2-815	5/16	-669	1-093
25		LFTC25	LFTC25A	LFTC25EC	1025	3	71,0	96,0	76,0	8,0	17,5	29,24
	7/8	LFTC7/8		LFTC7/8EC			2-795	3-780	2-992	5/16	-689	1-151
	15/16	LFTC15/16		LFTC15/16EC								
	1	LFTC1	LFTC1A	LFTC1EC								
30		LFTC30	LFTC30A	LFTC30EC	1030	4	84,0	112,0	90,5	10,0	20,5	33,62
	1 1/8	LFTC1 1/8		LFTC1 1/8EC			3-307	4-409	3-563	3/8	-807	1-324
	1 3/16	LFTC1 3/16		LFTC1 3/16EC								
	1 1/4	LFTC1 1/4	LFTC1 1/4A	LFTC1 1/4EC								
35		LFTC35	LFTC35A	LFTC35EC	1035	5	93,0	125,0	100,0	10,0	22,0	37,80
	1 1/4	LFTC1 1/4L	LFTC1 1/4AL	LFTC1 1/4ECL			3-661	4-921	3-937	3/8	-866	1-488
	1 3/8	LFTC1 3/8		LFTC1 3/8EC								
	1 7/16	LFTC1 7/16		LFTC1 7/16EC								

A2	A3	B	B1	B2	B3	s	s1	s2	d1	d2	ISO load ratings dynamic Cr	ISO load ratings static Cor	Rec. max. speed	Mass (approx.)
mm	inches										newtons lbf	newtons lbf	rev/ min	kg lb
30,43	-	27,38	-	28,54	-	11,55	6,55	-	24,21	28,58	9550	4760	7000	0,3
1-198	-	1-078	-	1-124	-	-455	-258	-	-953	1-125	2150	1070		0-7
32,92	36,04	30,96	25,77	30,92	43,62	12,75	7,56	17,12	28,50	33,30	12800	6580	6700	0,4
1-296	1-419	1-219	1-015	1-217	1-717	-502	-298	-674	1-122	1-311	2880	1480		0,9
32,82	36,35	34,11	27,35	30,92	44,40	14,32	7,56	17,49	34,01	38,10	14000	7880	6250	0,5
1-292	1-431	1-343	1-077	1-217	1-748	-564	-298	-689	1-339	1-500	3150	1770		1-1
38,07	41,50	38,10	31,21	35,68	48,42	15,93	9,04	18,32	40,00	44,45	19500	11300	5300	0,8
1-499	1-634	1-500	1-229	1-405	1-906	-627	-356	-721	1-575	1-750	4380	2540		1-8
41,74	44,71	42,88	34,90	38,88	51,18	17,53	9,55	18,89	46,69	55,58	25700	15300	4500	1,1
1-643	1-760	1-688	1-374	1-531	2-015	-690	-376	-744	1-838	2-188	5780	3440		2-4

FC SERIES

For housing tolerances to suit spigot 'H' see page 23

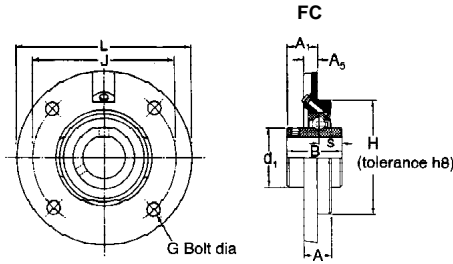

Note: Re-lubrication Hole - M5 x 0,8 Pitch

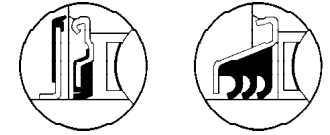
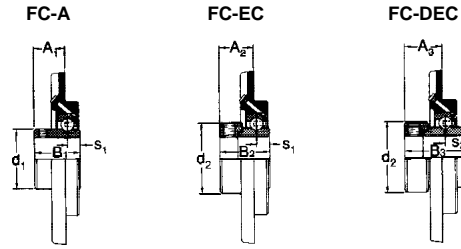

Bearing inserts with flinger seals shown on pages 91 and 92 can be fitted into these housings. The unit reference has the suffix 'FS', e.g. FC40FS.

Triple seal bearing inserts shown on pages 88 to 90 can be fitted into these housings. The unit reference has a prefix 'T', e.g. TFC40.

Shaft diameter	RHP designation				Basic bearing insert	Casting group	Dimensions					ISO load ratings dynamic Cr	static Cor	Rec. max. speed rev/min	Mass (approx.) kg	
	mm	inches	L	H			J	G	A	A1	newtons lbf					newtons lbf
20	3/4	FC20 FC3/4	FC20A FC3/4A	FC20EC FC3/4EC	FC20DEC FC3/4DEC	2	100,0 3-937	62,0 2-441	78,0 3-071	8 5/16	17,0 -669	16,29 -641	12800 2880	6580 1480	6700	0,7 1-5
25	7/8 15/16 1	FC25 FC7/8 FC15/16 FC1	FC25A FC7/8A FC15/16A FC1A	FC25EC FC7/8EC FC15/16EC FC1EC	FC25DEC FC7/8DEC FC15/16DEC FC1DEC	3	115,0 4-528	70,0 2-756	90,0 3-543	8 5/16	19,0 -748	17,34 -683	14000 3150	7880 1770	6250	0,9 1-9
30	1 1/8 1 3/16 1 1/4	FC30 FC1 1/8 FC1 3/16 FC1 1/4	FC30A FC1 1/8A FC1 3/16A FC1 1/4AR	FC30EC FC1 1/8EC FC1 3/16EC FC1 1/4ECR	FC30DEC FC1 1/8DEC FC1 3/16DEC FC1 1/4DECR	4	125,0 4-921	80,0 3-150	100,0 3-937	10 3/8	20,5 -807	20,22 -796	19500 4380	11300 2540	5300	1,1 2-5
35	1 1/4 1 3/8 1 7/16	FC35 FC1 1/4 FC1 3/8 FC1 7/16	FC35A FC1 1/4A FC1 3/8A FC1 7/16A	FC35EC FC1 1/4EC FC1 3/8EC FC1 7/16EC	FC35DEC FC1 1/4DEC FC1 3/8DEC FC1 7/16DEC	5	135,0 5-315	90,0 3-543	110,0 4-331	10 3/8	20,5 -807	24,40 -961	25700 5780	15300 3440	4500	1,5 3-3
40	1 1/2	FC40 FC1 1/2	FC40A FC1 1/2A	FC40EC FC1 1/2EC	FC40DEC FC1 1/2DEC	6	145,0 5-709	100,0 3-937	120,0 4-724	10 3/8	23,0 -906	29,18 -1-149	29100 6540	17900 4020	4000	1,8 3-9
45	1 5/8 1 11/16 1 3/4	FC45 FC1 5/8 FC1 11/16 FC1 3/4	FC45A FC1 5/8A FC1 11/16A FC1 3/4A	FC45EC FC1 5/8EC FC1 11/16EC FC1 3/4EC	FC45DEC FC1 5/8DEC FC1 11/16DEC FC1 3/4DEC	7	155,0 6-102	105,0 4-134	130,0 5-118	12 1/2	25,0 -984	28,18 -1-109	32500 7310	20500 4610	3700	2,2 4-8
50	1 7/8 1 15/16 2	FC50 FC1 7/8 FC1 15/16 FC2R	FC50A FC1 7/8A FC1 15/16A	FC50EC FC1 7/8EC FC1 15/16EC	FC50DEC FC1 7/8DEC FC1 15/16DEC	8	165,0 6-496	110,0 4-331	135,0 5-315	12 1/2	25,0 -984	31,52 -1-241	35000 7870	23200 5220	3400	2,8 6-2
55	2 2 1/8 2 3/16	FC55 FC2 FC2 1/8 FC2 3/16	FC55A FC2A FC2 1/8A FC2 3/16A	FC55EC FC2EC FC2 1/8EC FC2 3/16EC	FC55DEC FC2DEC FC2 1/8DEC FC2 3/16DEC	9	185,0 7-283	125,0 4-921	150,0 5-906	16 5/8	27,5 -1-083	33,30 -1-311	43500 9780	29200 6560	3100	4,0 8-8
60	2 1/4 2 3/8 2 7/16	FC60 FC2 1/4 FC2 3/8 FC2 7/16	FC60A FC2 1/4A FC2 3/8A FC2 7/16A	FC60EC FC2 1/4EC FC2 3/8EC FC2 7/16EC	FC60DEC FC2 1/4DEC FC2 3/8DEC FC2 7/16DEC	10	195,0 7-677	135,0 5-315	160,0 6-299	16 5/8	29,0 -1-142	38,65 -1-522	52500 11800	35900 8070	2800	4,7 10-4

A2	A3	A5	B	B1	B2	B3	s	s1	s2	d1	d2	ISO load ratings dynamic Cr	static Cor	Rec. max. speed	Mass (approx.)
21,45 -844	24,57 -967	8,0 -315	30,96 -1-219	25,77 -1-015	30,92 -1-217	43,62 -1-717	12,75 -502	7,56 -298	17,12 -674	28,50 -1-122	33,30 -1-311	12800 2880	6580 1480	6700	0,7 1-5
20,86 -821	24,41 -961	9,0 -354	34,11 -1-343	27,35 -1-077	30,92 -1-217	44,40 -1-748	14,32 -564	7,56 -298	17,49 -689	34,01 -1-339	38,10 -1-500	14000 3150	7880 1770	6250	0,9 1-9
24,64 -970	28,10 -1-106	9,5 -374	38,10 -1-500	31,21 -1-229	35,68 -1-405	48,42 -1-906	15,93 -627	9,04 -356	18,32 -721	40,00 -1-575	44,45 -1-750	19500 4380	11300 2540	5300	1,1 2-5
28,33 -1-115	31,29 -1-232	10,0 -394	42,88 -1-688	34,90 -1-374	38,88 -1-531	51,18 -2-015	17,53 -690	9,55 -376	18,89 -744	46,69 -1-838	55,58 -2-188	25700 5780	15300 3440	4500	1,5 3-3
31,59 -1-244	33,88 -1-334	11,5 -453	49,23 -1-938	41,18 -1-621	43,64 -1-718	56,34 -2-218	19,10 -752	11,05 -435	21,46 -845	52,70 -2-075	60,30 -2-374	29100 6540	17900 4020	4000	1,8 3-9
30,59 -1-204	32,88 -1-294	12,0 -472	49,23 -1-938	41,18 -1-621	43,64 -1-718	56,34 -2-218	19,10 -752	11,05 -435	21,46 -845	57,30 -2-256	63,50 -2-500	32500 7310	20500 4610	3700	2,2 4-8
31,63 -1-245	37,14 -1-462	13,0 -512	51,59 -2-031	43,54 -1-714	43,64 -1-718	62,70 -2-469	19,10 -752	11,05 -435	24,65 -970	62,20 -2-449	69,85 -2-750	35000 7870	23200 5220	3400	2,8 6-2
-	43,72 -1-721	15,0 -591	55,55 -2-187	-	-	71,44 -2-813	22,28 -877	-	27,82 -1-095	68,81 -2-709	76,20 -3-000	43500 9780	29200 6560	3100	4,0 8-8
-	45,89 -1-807	16,0 -630	65,07 -2-562	-	-	77,82 -3-064	25,45 -1-002	-	31,02 -1-221	75,34 -2-966	84,12 -3-312	52500 11800	35900 8070	2800	4,7 10-4

Please check availability

MFC SERIES

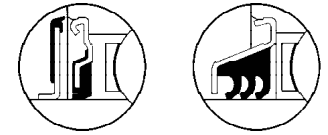
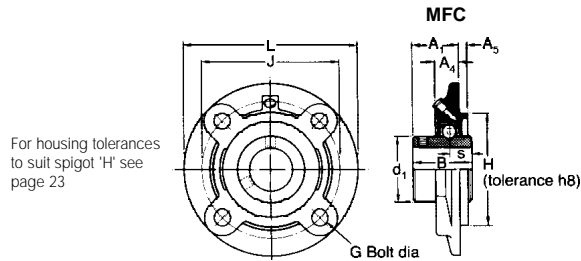

Bearing inserts with flinger seals shown on pages 91 and 92 can be fitted into these housings. The unit reference has the suffix 'FS' e.g. MFC30FS.

Triple seal bearing inserts shown on pages 88 to 90 can be fitted into these housings. The unit reference has a prefix 'T', e.g. TMFC30.

Shaft diameter		RHP designation	Basic bearing insert	Casting group	Dimensions							B
mm	inches				L	H	J	G	A1	A4	A5	
25	1 1 1/4	MFC25 MFC1 MFC1 1/4R	1030	1	111,1 4-374	76,20 3-000	92,08 3-625	8 5/16	33,32 1-312	21,0 -827	6,4 -252	38,10 1-500
30	1 3/16 1 1/4	MFC30 MFC1 3/16 MFC1 1/4	1035	2	127,0 5-000	85,72 3-375	104,78 4-125	10 3/8	33,32 1-312	19,0 -748	6,4 -252	42,88 1-688
35 40	1 3/8 1 7/16 1 1/2	MFC35 MFC40 MFC1 3/8 MFC1 7/16 MFC1 1/2	1040	3	133,4 5-252	92,07 3-625	111,12 4-375	10 3/8	38,10 1-500	19,0 -748	6,4 -252	49,23 1-938
45	1 11/16 1 3/4 2	MFC45 MFC1 11/16 MFC1 3/4 MFC2R	1050	4	155,6 6-126	107,95 4-250	130,18 5-125	10 7/16	39,67 1-562	19,0 -748	6,4 -252	51,59 2-031
50	1 7/8 1 15/16 2	MFC50 MFC1 7/8 MFC1 15/16 MFC2	1055	5	161,9 6-374	114,30 4-500	136,52 5-375	10 7/16	36,97 1-562	19,0 -748	6,4 -252	55,55 2-187
55	2 3/16 2 1/4	MFC55 MFC2 3/16 MFC2 1/4	1060	6	181,0 7-126	127,00 5-000	152,40 6-000	12 1/2	42,85 1-687	15,9 -626	9,5 -374	65,07 2-562
60 65	2 7/16 2 1/2	MFC60 MFC65R MFC2 7/16 MFC2 1/2	1070	7	193,7 7-626	139,70 5-500	165,10 6-500	12 1/2	46,02 1-812	15,9 -626	12,7 -500	74,63 2-938
65 70	2 11/16 2 3/4	MFC65 MFC70 MFC2 11/16 MFC2 3/4	1075	8	222,2 8-748	161,92 6-375	190,50 7-500	16 5/8	50,80 2-000	21,0 -827	12,7 -500	77,77 3-062
75 80	2 15/16 3 3 1/4	MFC75 MFC80 MFC2 15/16 MFC3 MFC3 1/4	1080	9	222,2 8-748	161,92 6-375	190,50 7-500	16 5/8	50,80 2-000	16,7 -657	12,7 -500	82,55 3-250
85 90	3 7/16 3 1/2	MFC85 MFC90 MFC3 7/16 MFC3 1/2	1090	10	260,4 10-252	187,32 7-375	219,08 8-625	20 3/4	67,46 2-656	29,4 1-157	12,7 -500	96,04 3-781
95 100	3 15/16 4	MFC95 MFC100 MFC3 15/16 MFC4	3095	11	298,4 11-748	228,60 9-000	260,35 10-250	20 3/4	88,90 3-500	46,0 1-811	12,7 -500	117,48 4-625

s	d1	ISO load ratings		Rec. max. speed	Mass (approx.)
		dynamic Cr	static Cor		
mm	inches	newtons	newtons	rev/min	kg
		lbf	lbf		lb

Please check availability

MST SERIES

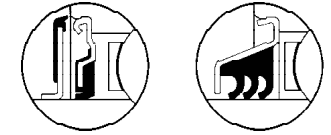
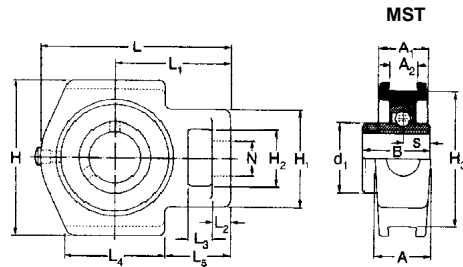

Bearing inserts with flinger seals shown on pages 91 and 92 can be fitted into these housings. The unit reference has the suffix 'FS', e.g. MST35FS.

Triple seal bearing inserts shown on pages 88 to 90 can be fitted into these housings. The unit reference has a prefix 'T', e.g. TMST35.

Shaft diameter	RHP designation	Basic bearing insert	Casting group	Dimensions							H	H ₁	
				L	L ₁	L ₂	L ₃	L ₄	L ₅				
mm	inches			mm inches									
25	MST25 MST1	1030	1	115,5 4-547	71,7 2-823	12,5 -492	16,5 -650	64,5 2-539	43,0 1-693	101,5 3-996	64,5 2-539		
30	MST30 MST1 ^{3/16} MST1 ^{1/4} **	1035	2	124,0 4-882	75,5 2-972	12,5 -492	16,5 -650	64,5 2-539	43,0 1-693	101,5 3-996	64,5 2-539		
35	MST35 MST1 ^{3/8} MST1 ^{7/16} MST1 ^{1/2}	1040	3	143,5 5-650	89,2 3-512	15,5 -610	20,5 -807	81,5 3-209	50,5 1-988	118,0 4-646	82,5 3-248		
40	MST40 MST1 ^{1/2}	1045	4	147,0 5-787	89,2 3-512	15,5 -610	20,5 -807	81,5 3-209	50,5 1-988	118,0 4-646	82,5 3-248		
45	MST45 MST1 ^{11/16} MST1 ^{3/4} MST1 ^{7/8}	1050	5	151,0 5-945	90,5 3-563	15,5 -610	20,5 -807	81,5 3-209	50,5 1-988	118,0 4-646	82,5 3-248		
50	MST50 MST1 ^{7/8} MST1 ^{15/16} MST1 ² **	1055	6	182,0 7-165	114,0 4-488	19,0 -748	32,0 1-260	97,5 3-839	70,0 2-756	146,0 5-748	101,0 3-976		
55	MST55 MST2 ^{3/16} MST2 ^{1/4} **	1060	7	192,0 7-559	119,0 4-685	19,0 -748	32,0 1-260	97,5 3-839	70,0 2-756	146,0 5-748	101,0 3-976		
60	MST60 MST2 ^{7/16} MST2 ^{1/2} **	1070	8	222,5 8-760	137,5 5-413	21,5 -846	32,0 1-260	120,5 4-744	77,0 3-031	166,5 6-555	113,0 4-449		
65 70	MST65 MST70 MST2 ^{11/16} MST2 ^{3/4} **	1075	9	222,5 8-760	137,5 5-413	21,5 -846	32,0 1-260	120,5 4-744	77,0 3-031	166,5 6-555	113,0 4-449		
75	MST75 MST2 ^{15/16} MST3 **	1080	10	231,5 9-114	139,5 5-492	20,5 -807	32,0 1-260	125,0 4-921	74,0 2-913	184,0 7-244	113,0 4-449		
80	MST80 MST3 ^{3/16} MST3 ^{1/4} **	1085	11	260,5 10-256	162,0 6-378	28,5 1-122	38,0 1-496	140,0 5-512	90,5 3-562	198,5 7-815	124,0 4-882		
85 90	MST85 MST90 MST3 ^{7/16} MST3 ^{1/2} MST3 ^{3/4}	1090	12	270,0 10-630	165,0 6-496	28,5 1-122	38,0 1-496	152,5 6-004	90,0 3-543	216,0 8-504	127,0 5-000		
95 100	MST95 MST100 MST3 ^{15/16} MST4	3095	13	317,5 12-500	190,5 7-500	32,0 1-260	38,0 1-496	175,0 6-890	103,0 4-055	260,5 10-256	152,5 6-004		

H ₂	H ₃	N	A	A ₁	A ₂	B	s	d _t	ISO load ratings		Rec. max. speed	Mass (approx.)
									dynamic C _r	static C _{or}		
mm	inches								newtons lbf	newtons lbf	rev/ min	kg lb
37,5 1-476	89,0 3-504	22,5 -886	36,5 1-437	30,0 1-181	13,50 -531	38,10 1-500	15,93 -627	40,00 1-575	19500 4380	11300 2540	5300	1,6 3-5
37,5 1-476	89,0 3-504	22,5 -886	36,5 1-437	30,0 1-181	13,50 -531	42,88 1-688	17,53 -690	46,69 1-838	25700 5780	15300 3440	4500	1,6 3-5
49,5 1-949	101,0 3-976	29,0 1-142	49,5 1-949	37,0 1-457	17,50 -689	49,23 1-938	19,10 -752	52,70 2-075	29100 6540	17900 4020	4000	2,7 6-0
49,5 1-949	101,0 3-976	29,0 1-142	49,5 1-949	37,0 1-457	17,50 -689	49,23 1-938	19,10 -752	57,30 2-256	32500 7310	20500 5220	3700	2,8 6-2
49,5 1-949	101,0 3-976	29,0 1-142	49,5 1-949	37,0 1-457	17,50 -689	51,59 2-031	19,10 -752	62,20 2-449	35000 7870	23200 5220	3400	2,8 6-2
64,0 2-520	130,0 5-118	35,0 1-378	63,5 2-500	46,5 1-831	27,00 1-063	55,55 2-187	22,28 -877	68,81 2-709	43500 9780	29200 6560	3100	4,2 9-3
64,0 2-520	130,0 5-118	35,0 1-378	63,5 2-500	46,5 1-831	27,00 1-063	65,07 2-562	25,45 1-002	73,34 2-966	52500 11800	35900 8070	2800	5,4 11-8
70,0 2-756	150,8 5-937	42,0 1-654	70,0 2-756	50,5 1-988	27,00 1-063	74,63 2-938	30,23 1-190	87,00 3-425	62000 13940	44000 9890	2450	7,9 17-5
70,0 2-756	150,8 5-937	42,0 1-654	70,0 2-756	50,5 1-988	27,00 1-063	77,77 3-062	33,37 1-314	92,00 3-622	66000 14840	49300 11080	2300	8,4 18-5
70,0 2-756	165,1 6-500	42,0 1-654	70,0 2-756	54,0 2-126	27,00 1-063	82,55 3-250	33,37 1-314	98,50 3-878	72500 16300	53000 11910	2150	9,0 19-9
73,0 2-874	173,0 6-811	47,5 1-870	79,5 3-130	68,5 2-697	46,05 1-813	85,72 3-375	34,18 1-346	106,02 4-174	83500 18770	63800 14340	2000	13,7 30-2
73,0 2-874	190,5 7-500	47,5 1-870	79,5 3-130	68,5 2-697	46,05 1-813	96,04 3-781	39,73 1-564	111,66 4-396	96000 21580	71500 16070	1900	16,8 37-0
85,5 3-366	235,0 9-252	54,5 2-146	98,5 3-878	82,5 3-248	55,55 2-187	117,48 4-625	49,27 1-940	130,43 5-135	143000 32150	110000 24730	1600	22,2 49-0

** For these bore sizes select from ST series (see page 56)

Please check availability

MST 1000-K SERIES

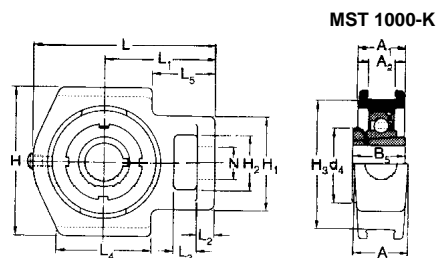

Shaft diameter	RHP designation			Basic bearing insert	Casting group	Dimensions					
	complete unit	sleeve, nut & lockwasher assembly only	unit without sleeve, nut & lockwasher			L	L1	L2	L3	L4	L5
mm inches						mm inches					
20 3/4	MST1025-20K MST1025-2/4K	H305 HE305-3/4	MST1025K	1025	ST3	98,0 3-858	62,0 2-441	11,5 -453	16,0 -630	50,5 1-988	36,5 1-437
25 15/16 1	MST1030-25K MST1030-15/16K MST1030-1K	H306 HE306-15/16 HE306-1	MST1030K	1030	1	115,5 4-547	71,7 2-823	12,5 -492	16,5 -650	64,5 2-539	43,0 1-693
30 1 1/8 1 3/16	MST1035-30K MST1035-1 1/8K MST1035-1 3/16K	H307 HE307-1 1/8 HE307-1 3/16	MST1035K	1035	2	124,0 4-882	75,5 2-972	12,5 -492	16,5 -650	64,5 2-539	43,0 1-693
35 1 1/4 1 3/8	MST1040-35K MST1040-1 1/4K MST1040-1 3/8K	H308 HE308-1 1/4 HE308-1 3/8	MST1040K	1040	3	143,5 5-650	89,2 3-512	15,5 -610	20,5 -807	81,5 3-209	50,5 1-988
40 1 7/16 1 1/2	MST1045-40K MST1045-1 7/16K MST1045-1 1/2K	H309 HE309-1 7/16 HE309-1 1/2	MST1045K	1045	4	147,0 5-787	89,2 3-512	15,5 -610	20,5 -807	81,5 3-209	50,5 1-988
45 1 11/16 1 3/4	MST1050-45K MST1050-1 11/16K MST1050-1 3/4K	H310 HE310-1 11/16 HE310-1 3/4	MST1050K	1050	5	151,0 5-945	90,5 3-563	15,5 -610	20,5 -807	81,5 3-209	50,5 1-988
50 1 15/16 2	MST1055-50K MST1055-1 15/16K MST1055-2K	H311 HE311-1 15/16 HE311-2	MST1055K	1055	6	182,0 7-165	114,0 4-488	19,0 -748	32,0 1-260	97,5 3-839	70,0 2-756

H	H1	H2	H3	N	A	A1	A2	B5	d4	ISO load ratings		Rec. max. speed	Mass (approx.)
										dynamic Cr	static Cor		
mm inches										newtons lbf	newtons lbf	rev/min	kg lb
88,5 3-484	58,5 2-303	32,0 1-260	76,0 2-992	22,5 -886	36,0 1-417	27,5 1-083	13,50 -531	29,0 1-142	38,0 1-496	14000 3150	7880 1770	6250	1,0 2-2
101,5 3-996	64,5 2-539	37,5 1-476	89,0 3-504	22,5 -886	36,5 1-437	30,0 1-181	13,50 -531	31,0 1-220	45,0 1-772	19500 4380	11300 2540	5300	1,6 3-5
101,5 3-996	64,5 2-539	37,5 1-476	89,0 3-504	22,5 -886	36,5 1-437	30,0 1-181	13,50 -531	35,0 1-378	52,0 2-047	25700 5780	15300 3440	4500	1,6 3-5
118,0 4-646	82,5 3-248	49,5 1-949	101,0 3-976	29,0 1-142	49,5 1-949	37,0 1-457	17,50 -689	36,0 1-417	58,0 2-283	29100 6540	17900 4020	4000	2,7 6-0
118,0 4-646	82,5 3-248	49,5 1-949	101,0 3-976	29,0 1-142	49,5 1-949	37,0 1-457	17,50 -689	39,0 1-535	65,0 2-559	32500 7310	20500 4610	3700	2,8 6-2
118,0 4-646	82,5 3-248	49,5 1-949	101,0 3-976	29,0 1-142	49,5 1-949	37,0 1-457	17,50 -689	42,0 1-654	70,0 2-756	35000 7870	23200 5220	3400	2,8 6-2
146,0 5-748	101,0 3-976	64,0 2-520	130,0 5-118	35,0 1-378	63,5 2-500	46,5 1-831	27,00 1-063	45,0 1-772	75,0 2-953	43500 9780	29200 6560	3100	4,2 9-3

Please check availability

BT SERIES

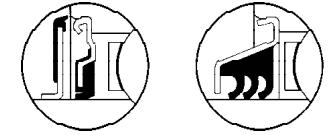
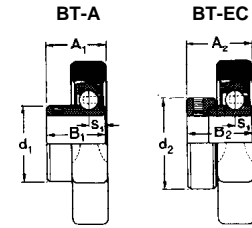
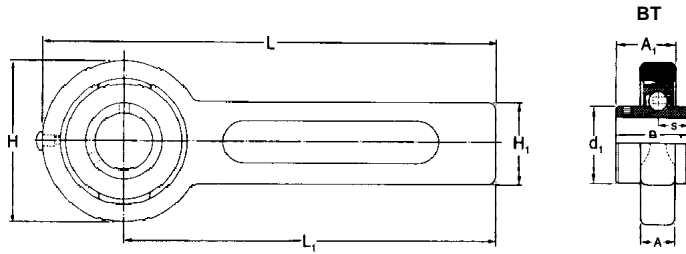

Bearing inserts with flinger seals shown on pages 91 and 92 can be fitted into these housings. The unit reference has the suffix 'FS' e.g. BT35FS.

Triple seal bearing inserts shown on pages 88 and 90 can be fitted into these housings. The unit reference has a prefix 'T', e.g. TBT35.

Shaft diameter		RHP designation			Basic bearing group insert	Casting group	Dimensions					
							H	H ₁	L	L ₁	A	A ₁
mm	inches						mm	inches				
25	7/8 15/16 1	BT25 BT7/8 BT15/16 BT1	BT25A BT1A	BT25EC BT7/8EC BT15/16EC BT1EC	1025	3	78,0 3.071	42,5 1.673	264,0 10.394	225,0 8.858	22,0 0.866	30,57 1.204
30	1 3/16	BT30L			1035	5	98,0	42,5	274,0	225,0	22,0	36,13
35	1 1/4 1 3/8 1 7/16	BT35 BT13/16L BT11/4 BT13/8 BT17/16	BT35A BT11/4A	BT35EC			98,0 3.858	42,5 1.673	274,0 10.787	225,0 8.858	22,0 0.866	36,13 1.422

A ₂	B	B ₁	B ₂	s	s ₁	d ₁	d ₂	ISO load ratings		Rec. max. speed	Mass (approx.)
								dynamic	static	rev/min	kg
mm								newtons	newtons		lb
inches								lbf	lbf		lb
34,2	34,11	27,35	30,92	14,32	7,56	34,01	38,10	14000	7880	6250	1,8
1.346	1.343	1.077	1.217	.564	.298	1.339	1.500	3150	1770		4.0
40,2	42,88	34,90	38,88	17,53	9,55	46,69	55,58	25700	15300	4500	2,3
1.583	1.688	1.374	1.531	.690	.376	1.838	2.188	5780	3440		5.0

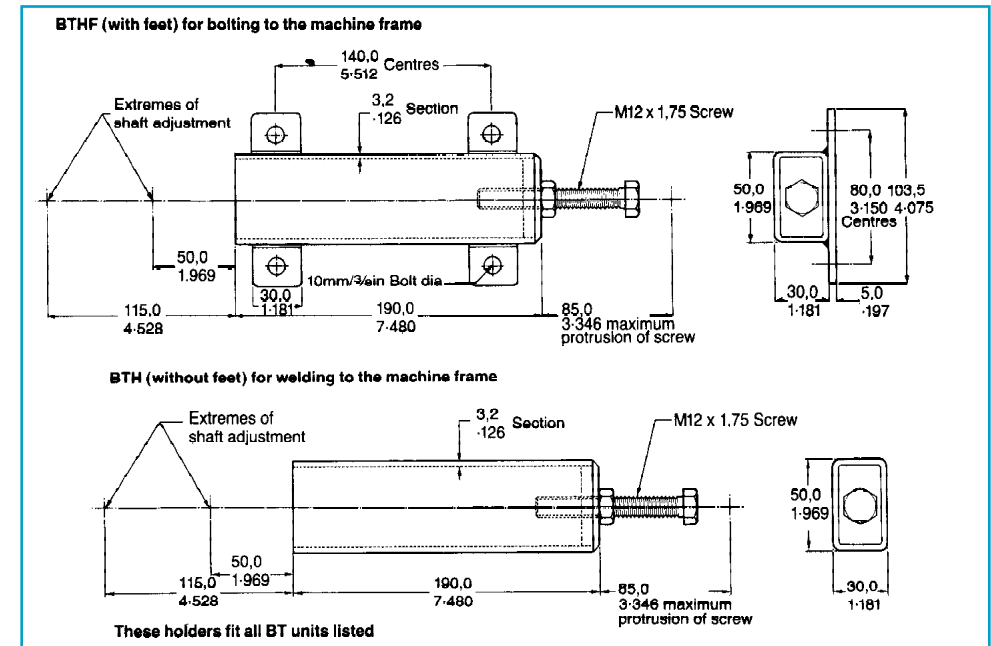

Please check availability

SLC SERIES

For housing tolerances to suit outside dia 'L' see page 23

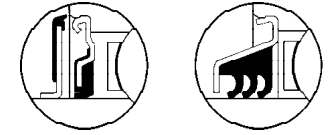
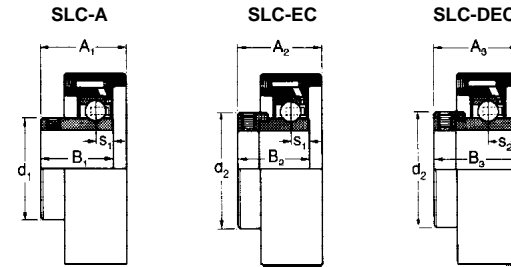
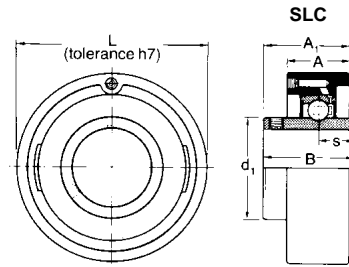

Bearing inserts with flinger seals shown on pages 91 and 92 can be fitted into these housings. The unit reference has the suffix 'FS', e.g. SLC25FS.

Triple seal bearing inserts shown on pages 88 to 90 can be fitted into these housings. The unit reference has a prefix 'T', e.g. TSLC25.

Shaft diameter	RHP designation	Basic bearing insert	Casting group	Dimensions						ISO load ratings dynamic Cr	ISO load ratings static Cor	Rec. max. speed	Mass (approx.)	
				L	A	A1	A2	A3	B					
mm inches				mm inches						newtons lbf	newtons lbf	rev/min	kg lb	
12 15 16 17	SLC12 SLC15 SLC16 SLC17	SLC12EC SLC15EC SLC16EC SLC17EC	1017	1	68,287 2.6885	22,22 -875	24,21 -953	30,35 1.195	-	27,38 1.078			7000	0,6 1.3
20	SLC20 SLC3/4	SLC20A SLC3/4A	1020	2	74,637 2.9385	22,22 -875	29,39 1.157	34,54 1.360	37,67 1.483	30,96 1.219			6700	0,7 1.5
25	SLC25 SLC7/8 SLC15/16 1	SLC25A SLC7/8A SLC15/16A SLC1A	1025	3	79,400 3.1260	26,19 1.031	32,94 1.297	36,52 1.438	40,06 1.577	34,11 1.343			6250	0,8 1.8
30	SLC30 SLC11/8 SLC13/16 SLC11/4R	SLC30A SLC11/8A SLC13/16A SLC11/4AR	1030	4	88,925 3.5010	27,78 1.094	36,12 1.422	40,56 1.597	43,99 1.732	38,10 1.500			5300	1,1 2.5
35	SLC35 SLC11/4 SLC13/8 SLC17/16	SLC35A SLC11/4A SLC13/8A SLC17/16A	1035	5	98,450 3.8760	30,96 1.219	40,87 1.609	44,81 1.764	47,78 1.881	42,88 1.688			4500	1,4 3.1
40	SLC40 SLC11/2	SLC40A SLC11/2A	1040	6	106,387 4.1885	37,31 1.469	48,84 1.923	51,28 2.019	53,57 2.109	49,23 1.938			4000	2,0 4.4
45	SLC45 SLC15/8 SLC111/16 SLC13/4	SLC45A SLC15/8A SLC111/16A SLC13/4A	1045	7	111,150 4.3760	36,51 1.437	48,44 1.907	50,88 2.003	53,16 2.093	49,23 1.938			3700	2,1 4.7
50	SLC50 SLC17/8 SLC115/16 SLC2R	SLC50A SLC17/8A SLC115/16A SLC2R	1050	8	115,913 4.5635	37,31 1.469	51,18 2.015	51,28 2.019	56,72 2.233	51,59 2.031			3400	2,3 5.1
55	SLC55 SLC2 SLC21/8 SLC23/16	SLC55DEC SLC2DEC SLC21/8DEC SLC23/16DEC	1055	9	125,437 4.9385	40,48 1.594	53,57 2.109	-	63,83 2.513	55,55 2.187			3100	2,9 6.3
60	SLC60 SLC21/4 SLC23/8 SLC27/16	SLC60DEC SLC21/4DEC SLC23/8DEC SLC27/16DEC	1060	10	149,250 5.8760	41,28 1.625	60,30 2.374	-	67,39 2.653	65,07 2.562			2800	4,4 9.7
65	SLC65 SLC21/2	SLC65DEC SLC21/2DEC	1065	10/65	149,250 5.8760	41,28 1.625	60,30 2.374	-	67,39 2.653	65,07 2.562			2600	4,5 9.9

B1	B2	B3	s	s1	s2	d1	d2	ISO load ratings		Rec. max. speed	Mass (approx.)	
								dynamic Cr	static Cor			
mm inches								newtons lbf	newtons lbf	rev/min	kg lb	
-	28,54 1.124	-	-	11,55 -455	6,55 -258	-	24,21 -953	28,58 1.125	9550 2150	4760 1070	7000	0,6 1.3
25,77 1.015	30,92 1.217	43,62 1.717	12,75 -502	7,56 -298	17,12 -674	28,50 1.122	33,30 1.311	12800 2880	6580 1480	6700	0,7 1.5	
27,35 1.077	30,92 1.217	44,40 1.748	14,32 -564	7,56 -298	17,49 -689	34,01 1.339	38,10 1.500	14000 3150	7880 1770	6250	0,8 1.8	
31,21 1.229	35,68 1.405	48,42 1.906	15,93 -627	9,04 -356	18,32 -721	40,00 1.575	44,45 1.750	19500 4380	11300 2540	5300	1,1 2.5	
34,90 1.374	38,88 1.531	51,18 2.015	17,53 -690	9,55 -376	18,89 -744	46,69 1.838	55,58 2.188	25700 5780	15300 3440	4500	1,4 3.1	
41,18 1.621	43,64 1.718	56,34 2.218	19,10 -752	11,05 -435	21,46 -845	52,70 2.075	60,30 2.374	29100 6540	17900 4020	4000	2,0 4.4	
41,18 1.621	43,64 1.718	56,34 2.218	19,10 -752	11,05 -435	21,46 -845	57,30 2.256	63,50 2.500	32500 7310	20500 4610	3700	2,1 4.7	
43,54 1.714	43,64 1.718	62,70 2.469	19,10 -752	11,05 -435	24,65 -970	62,20 2.449	69,85 2.750	35000 7870	23200 5220	3400	2,3 5.1	
-	-	71,44 2.813	22,28 -877	-	27,82 -1.095	68,81 2.709	76,20 3.000	43500 9780	29200 6560	3100	2,9 6.3	
-	-	77,82 3.064	25,45 -1.002	-	31,02 -1.221	75,34 2.966	84,12 3.312	52500 11800	35900 8070	2800	4,4 9.7	
-	-	77,82 3.064	25,45 -1.002	-	31,02 -1.221	82,40 3.244	87,33 3.438	57500 12930	40000 8990	2600	4,5 9.9	

Please check availability

MSC SERIES

For housing tolerances to suit outside dia 'L' see page 23.

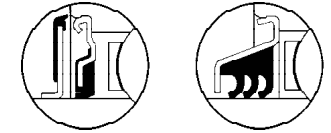
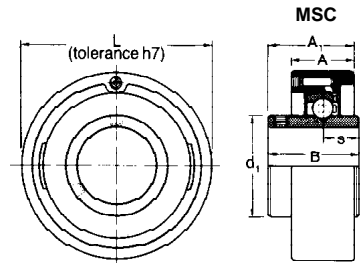

Bearing inserts with flinger seals shown on pages 91 and 92 can be fitted into these housings. The unit reference has the suffix 'FS' e.g. MSC1³/₁₆FS.

Triple seal bearing inserts shown on pages 88 to 90 can be fitted into these housings. The unit reference has a prefix 'T', e.g. TMSC1³/₁₆.

Shaft diameter		RHP designation	Basic insert	Casting bearing	Dimensions group L					d ₁
mm	inches				L	A	A ₁	B	s	
25		MSC25	1030	1	88,925	27,78	36,12	38,10	15,93	40,00
30		**			3-5010	1-094	1-422	1-500	-627	1-575
35	1	MSC1	1035	2	98,450	30,96	40,87	42,88	17,53	46,69
	1 ³ / ₁₆	**			3-8760	1-219	1-609	1-688	-690	1-838
	1 ¹ / ₄	MSC1³/₁₆								
40		**	1040	3	106,387	37,31	48,84	49,23	19,10	52,70
	1 ³ / ₈	MSC1³/₈			4-1885	1-469	1-923	1-938	-752	2-075
	1 ⁷ / ₁₆	MSC1⁷/₁₆								
45	1 ¹ / ₂	**	1045	4	111,150	36,51	48,44	49,23	19,10	57,30
		MSC1¹/₂			4-3760	1-437	1-907	1-938	-752	2-256
50		**	1050	5	115,913	37,31	51,18	51,59	19,10	62,20
	1 ¹¹ / ₁₆	MSC1¹¹/₁₆			4-5635	1-469	2-015	2-031	-752	2-449
	1 ³ / ₄	MSC1³/₄								
55		**	1055	6	125,437	40,48	53,57	55,55	22,28	68,81
	1 ⁷ / ₈	MSC1⁷/₈			4-9385	1-594	2-109	2-187	-877	2-709
	1 ¹⁵ / ₁₆	MSC1¹⁵/₁₆								
	2	**	1060	7	149,250	41,28	60,30	65,07	25,45	75,34
	2 ³ / ₁₆	MSC2³/₁₆			5-8760	1-625	2-374	2-562	1-002	2-966
	2 ¹ / ₄	**								
65		MSC65	1070	8	158,775	50,80	69,80	74,63	30,23	87,00
70		MSC70			6-2510	2-000	2-748	2-938	1-190	3-425
	2 ⁷ / ₁₆	MSC2⁷/₁₆								
	2 ¹ / ₂	MSC2¹/₂								
75		MSC75	1075	9	168,300	50,80	69,80	77,77	33,37	92,00
	2 ¹¹ / ₁₆	MSC2¹¹/₁₆			6-6260	2-000	2-748	3-062	1-314	3-622
	2 ³ / ₄	MSC2³/₄								
80		MSC80	1080	10	177,825	55,56	76,99	82,55	33,37	98,50
	2 ¹⁵ / ₁₆	MSC2¹⁵/₁₆			7-0010	2-187	3-031	3-250	1-314	3-878
	3	MSC3								
85		MSC85	1085	11	188,937	63,50	83,29	85,72	34,18	106,02
	3 ³ / ₁₆	MSC3³/₁₆			7-4385	2-500	3-279	3-375	1-346	4-174
	3 ¹ / ₄	MSC3¹/₄								
90		MSC90	1090	12	207,987	63,50	88,06	96,04	39,73	111,66
	3 ⁷ / ₁₆	MSC3⁷/₁₆			8-1885	2-500	3-467	3-781	1-564	4-396
	3 ¹ / ₂	MSC3¹/₂								
95		MSC95	3095	13	241,325	76,20	106,38	117,48	49,27	130,43
100		MSC100			9-5010	3-000	4-188	4-625	1-940	5-135
	3 ¹⁵ / ₁₆	MSC3¹⁵/₁₆								
	4	MSC4								

ISO load ratings		Rec. max. speed	Mass (approx.)
dynamic C _r	static C _{0r}		
newtons	newtons	rev/min	kg
lbf	lbf		lb

**For these bore sizes select from SLC Series (see page 64)

Please check availability

SCHB SERIES (BSP thread)
SCH SERIES (metric thread)**

**These series units are identical to SCHB series except for thread details

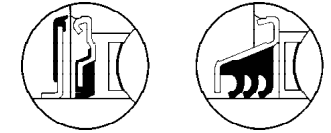
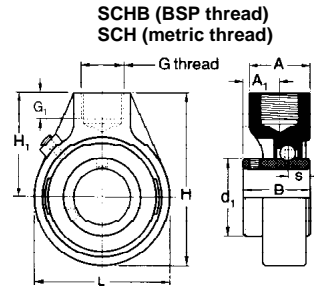

Bearing inserts with flinger seals shown on pages 91 and 92 can be fitted into these housings. The unit reference has the suffix 'FS' e.g. SCHB35FS.

Triple seal bearing inserts shown on pages 88 to 90 can be fitted into these housings. The unit reference has a prefix 'T', e.g. TSCH35

Shaft diameter	RHP designation		Basic bearing insert	Casting group	Dimensions G (BSP)	G (metric)	G ₁	L	H	H ₁	A
	BSP thread	metric thread									
mm inches							mm inches				
20 3/4	SCHB20 SCHB3/4	SCH20 SCH3/4	1020	0	1/2	M16 x 2,00	19,0 -748	67,0 2-638	91,6 3-606	57,2 2-252	34,0 1-339
25 7/8 30 1 1 1/8	SCHB25 SCHB30 SCHB7/8 SCHB1 SCHB1 1/8	SCH25 SCH30 SCH7/8 SCH1 SCH1 1/8	1030	2/0	1/2	M20 x 2,50	16,0 -630	89,0 3-504	107,5 4-232	61,9 2-437	33,5 1-319
35 1 3/16 1 1/4 1 3/8	SCHB35 SCHB1 3/16 SCHB1 1/4 SCHB1 3/8	SCH35 SCH1 3/16 SCH1 1/4 SCH1 3/8	1035	1	3/4	M24 x 3,00	19,0 -748	97,0 3-819	119,0 4-685	69,8 2-748	39,5 1-555
40 1 7/16 1 1/2	SCHB40 SCHB1 7/16 SCHB1 1/2	SCH40 SCH1 7/16 SCH1 1/2	1040	2	3/4	M24 x 3,00	19,0 -748	107,0 4-213	127,5 5-020	73,0 2-874	39, 1-555
45 1 11/16 50 1 3/4 1 7/8 1 15/16 2	SCHB45 SCHB50 SCHB1 11/16 SCHB1 3/4 SCHB1 7/8 SCHB1 15/16 SCHB2	SCH45 SCH50 SCH1 11/16 SCH1 3/4 SCH1 7/8 SCH1 15/16 SCH2	1050	3	1	M24 x 3,00	21,0 -827	121,0 4-764	144,0 5-669	82,6 3-252	47,5 1-870
55 2 3/16 60 2 1/4 2 3/8 2 7/16 2 1/2	SCHB55 SCHB60 SCHB2 3/16 SCHB2 1/4 SCHB2 3/8 SCHB2 7/16 SCHB2 1/2	SCH55 SCH60 SCH2 3/16 SCH2 1/4 SCH2 3/8 SCH2 7/16 SCH2 1/2	1060	4	1 1/4	M42 x 4,50	29,0 1-142	146,5 5-768	175,0 6-890	101,6 4-000	58,5 2-303
65 2 11/16 70 2 3/4 75 2 7/8 2 15/16	SCHB65 SCHB70 SCHB75 SCHB2 11/16 SCHB2 3/4 SCHB2 7/8 SCHB2 15/16	SCH65 SCH70 SCH75 SCH2 11/16 SCH2 3/4 SCH2 7/8 SCH2 15/16	1075	5	1 1/2	M48 x 5,00	32,0 1-260	165,0 6-496	200,6 7-898	117,5 4-626	70,0 2-756
80 3 3 3/16	SCHB80 SCHB3 SCHB3 3/16	SCH80 SCH3 SCH3 3/16	1080	6	1 1/2	M48 x 5,00	32,0 1-260	174,5 6-870	211,5 8-327	123,8 4-874	71,5 2-815

A ₁	B	s	d _i	ISO load ratings		Rec. max. speed	Mass (approx.)
				dynamic C _r	static C _{or}		
mm inches				newtons lbf	newtons lbf	rev/min	kg lb
18,26 -719	30,96 1-219	12,75 -502	28,50 1-122	12800 2880	6580 1480	6700	0,8 1-8
22,22 -875	38,10 1-500	15,93 -627	40,00 1-575	19500 4380	11300 2540	5300	1,2 2-7
25,40 1-000	42,88 1-688	17,53 -690	46,69 1-838	25700 5780	15300 3440	4500	1,5 3-2
27,79 1-094	49,23 1-938	19,10 -752	52,70 2-075	29100 6540	17900 4020	4000	1,6 3-6
27,79 1-094	51,59 2-031	19,10 -752	62,20 2-449	35000 7870	23200 5220	3400	2,2 4-8
30,94 1-218	65,07 2-562	25,45 1-002	75,34 2-966	52500 11800	35900 8070	2800	3,5 7-7
30,94 1-218	65,07 2-562	25,45 1-002	75,34 2-966	57500 12930	40000 8990	2660	3,4 7-5
34,94 1-376	77,77 3-062	33,37 1-314	92,00 3-622	66000 14840	49300 11080	2300	6,8 14-9
41,29 1-626	82,55 3-250	33,37 1-314	98,50 3-878	72500 16300	53000 11910	2150	8,1 17-8

Please check availability

Self-Lube pressed steel flange bearing units (zinc plated housings)

SLFE SERIES (ISO)

Housings of groups 6 to 10 inclusive have four bolt holes

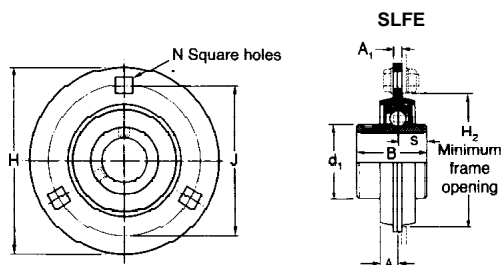

Note: these units are not re-greaseable.

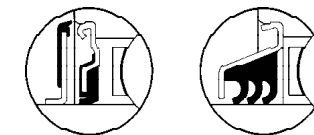
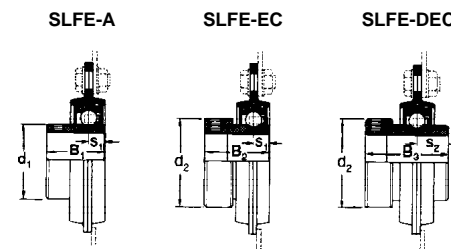

Bearing inserts with flinger seals shown on pages 91 and 92 can be fitted into these housings. The unit reference has the suffix 'FS', e.g. SLFE25FS.

Triple seal bearing inserts shown on pages 88 to 90 can be fitted into these housings. The unit reference has a prefix 'T', e.g. TSLFE25.

Shaft diameter		RHP designation		Basic bearing insert	Housing group	Dimensions				N	A	A ₁
mm	inches					H	H ₂	J				
12		SLFE12	SLFE12EC	2017	1	81,0	49,0	63,5	7,1	6,7	4,0	
15		SLFE15	SLFE15EC			3-189	1-929	2-500	-280	-264	-157	
16		SLFE16	SLFE16EC									
17		SLFE17	SLFE17EC									
1/2		SLFE1/2	SLFE1/2EC									
5/8		SLFE3/8	SLFE3/8EC									
20		SLFE20	SLFE20EC	1020	2	90,5	55,0	71,5	8,7	7,7	4,0	
3/4		SLFE3/4	SLFE3/4EC			3-563	2-165	2-815	-343	-303	-157	
25		SLFE25	SLFE25EC	1025	3	95,2	60,0	76,0	8,7	8,7	4,0	
7/8		SLFE7/8	SLFE7/8EC			3-748	2-362	2-992	-343	-343	-157	
15/16		SLFE15/16	SLFE15/16EC									
1		SLFE1	SLFE1EC									
30		SLFE30	SLFE30EC	1030	4	112,7	71,0	90,5	10,5	9,0	5,0	
1 1/8		SLFE1 1/8	SLFE1 1/8EC			4-437	2-795	3-563	-413	-354	-197	
1 3/16		SLFE1 3/16	SLFE1 3/16EC									
1 1/4		SLFE1 1/4	SLFE1 1/4EC									
35		SLFE1 1/4L	SLFE1 1/4ALECL	1035	5	122,2	81,0	100,0	10,5	10,0	5,0	
1 3/8		SLFE35	SLFE35EC			4-811	3-189	3-937	-413	-394	-197	
1 7/16		SLFE1 7/16	SLFE1 7/16EC									
40		SLFE40	SLFE40EC	1040	6	147,8	91,0	119,0	13,5	10,0	7,0	
1 1/2		SLFE1 1/2	SLFE1 1/2EC			5-819	3-583	4-685	-531	-394	-276	
45		SLFE45	SLFE45EC	1045	7	149,2	97,00	120,5	13,5	10,0	7,0	
1 5/8		SLFE1 5/8	SLFE1 5/8EC			5-874	3-819	4-744	-531	-394	-276	
1 11/16		SLFE1 11/16	SLFE1 11/16EC									
1 3/4		SLFE1 3/4	SLFE1 3/4EC									
50		SLFE50	SLFE50EC	1050	8	155,6	102,0	127,0	13,5	10,5	8,0	
1 7/8		SLFE1 7/8	SLFE1 7/8EC			6-126	4-016	5-000	-531	-413	-315	
1 15/16		SLFE1 15/16	SLFE1 15/16EC									
2		SLFE2R	SLFE2R									
55		SLFE55	SLFE55EC	1055	9	166,6	113,0	138,0	13,5	10,7	8,0	
2 1/8		SLFE2 1/8	SLFE2 1/8EC			6-559	4-449	5-433	-531	-421	-315	
2 3/16		SLFE2 3/16	SLFE2 3/16EC									
60		SLFE60	SLFE60EC	1060	10	176,2	122,0	147,6	13,5	11,9	8,0	
2 1/4		SLFE2 1/4	SLFE2 1/4EC			6-937	4-803	5-811	-531	-469	-315	
2 1/16		SLFE2 1/16	SLFE2 1/16EC									

Please check availability

B	B ₁	B ₂	B ₃	s	s ₁	s ₂	d ₁	d ₂	Max. radial housing load	Rec.max. speed	Mass (approx.)
27,38	-	28,54	-	11,55	6,55	-	24,21	28,58	2670	3000	0,2
1-078	-	1-124	-	-455	-258	-	-953	1-125	600		0,5
30,96	25,77	30,92	43,62	12,75	7,56	17,12	28,50	33,30	3110	3000	0,3
1-219	1-015	1-217	1-717	-502	-298	-674	1-122	1-311	700		0,7
34,11	27,35	30,92	44,40	14,32	7,56	17,49	34,01	38,10	3560	2500	0,4
1-343	1-077	1-217	1-748	-564	-298	-689	1-339	1-500	800		0,9
38,10	31,21	35,68	48,42	15,93	9,04	18,32	40,00	44,45	4890	2500	0,7
1-500	1-229	1-405	1-906	-627	-356	-721	1-575	1-750	1100		1,5
42,88	34,90	38,88	51,18	17,53	9,55	18,89	46,69	55,58	6250	2000	0,9
1-688	1-374	1-531	2-015	-690	-376	-744	1-838	2-188	1400		2,0
49,23	41,18	43,64	56,34	19,10	11,05	21,46	52,70	60,30	7550	2000	1,5
1-938	1-621	1-718	2-218	-752	-435	-845	2-075	2-374	1700		3,3
49,23	41,18	43,64	56,34	19,10	11,05	21,46	57,30	63,50	7550	2000	1,6
1-938	1-621	1-718	2-218	-752	-435	-845	2-256	2-500	1700		3,5
51,59	43,54	43,64	62,70	19,10	11,05	24,65	62,20	69,85	8450	1500	1,8
2-031	1-714	1-718	2-469	-752	-435	-970	2-449	2-750	1900		4,0
55,55	-	-	71,44	22,28	-	27,82	68,81	76,20	10200	1500	2,2
2-187	-	-	2-813	-877	-	1-095	2-709	3-000	2300		4,8
65,07	-	-	77,82	25,45	-	31,02	75,34	84,12	11300	1500	2,5
2-562	-	-	3-064	1-002	-	1-221	2-966	3-312	2540		5,5

A modified version of these units is available if a Protector is to be fitted, see page 102 for details.

Self-Lube pressed steel flange bearing units (zinc plated housings)

SLFT SERIES (ISO)

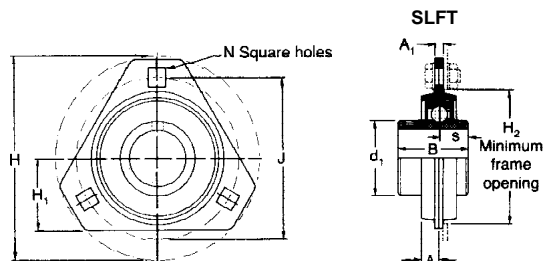

Note: these units are not re-greaseable.

Shaft diameter		RHP designation	Basic bearing insert	Housing group	Dimensions								
					H	H ₁	H ₂	J	N	A			
mm	inches				mm inches								
25	7/8	SLFT25	SLFT25A	SLFT25EC	SLFT25DEC	1025	3	95,2	34,2	60,0	76,0	8,7	8,7
	15/16	SLFT7/8	SLFT7/8A	SLFT7/8EC	SLFT7/8DEC								
	1	SLFT15/16	SLFT15/16A	SLFT15/16EC	SLFT15/16DEC								
30	11/8	SLFT30	SLFT30A	SLFT30EC	SLFT30DEC	1030	4	112,7	40,2	71,0	90,5	10,5	9,0
	13/16	SLFT11/8	SLFT11/8A	SLFT11/8EC	SLFT11/8DEC								
	1 1/4	SLFT13/16	SLFT13/16A	SLFT13/16EC	SLFT13/16DEC								
35	1 1/4	SLFT11/4	SLFT11/4A	SLFT11/4EC	SLFT11/4DEC	1035	5	122,2	44,2	81,0	100,0	10,5	10,0
	1 3/8	SLFT11/4LSLFT11/4AL	SLFT11/4ECL	SLFT11/4DECL									
	1 7/16	SLFT35	SLFT35A	SLFT35EC	SLFT35DEC								

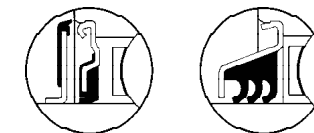
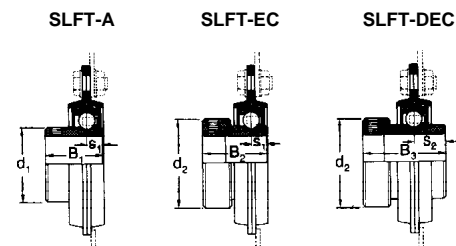

Bearing inserts with flinger seals shown on pages 91 and 92 can be fitted into these housings. The unit reference has the suffix 'FS', e.g. SLFT35FS.

Triple seal bearing inserts shown on pages 88 to 90 can be fitted into these housings. The unit reference has a prefix 'T', e.g. TSLFT35.

A ₁		B	B ₁	B ₂	B ₃	s	s ₁	s ₂	d ₁	d ₂	Max. radial housing load	Rec.max. speed	Mass (approx.)
mm	inches										newtons lbf	rev/ min	kg lb
4,0	-157	34,11	27,35	30,92	44,40	14,32	7,56	17,49	34,01	38,10	3560	2500	0,3
5,0	-197	38,10	31,21	35,68	48,42	15,93	9,04	18,32	40,00	44,45	4890	2500	0,5
5,0	-197	42,88	34,90	38,88	51,18	17,53	9,55	18,89	46,69	55,58	6250	2000	0,7

A modified version of these units is available if a Protector is to be fitted, see page 102 for details.

SLFL SERIES (ISO)

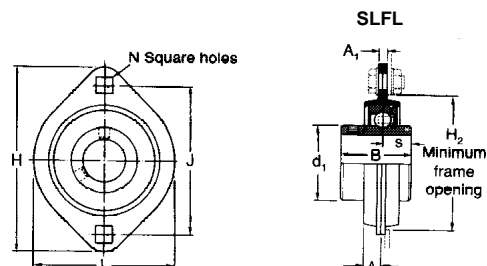

Note: these units are not re-greaseable.

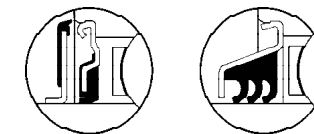
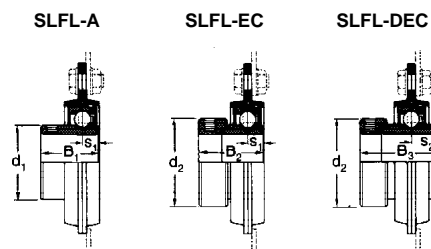

Bearing inserts with flinger seals shown on pages 91 and 92 can be fitted into these housings. The unit reference has the suffix 'FS', e.g. SLFL1FS.

Triple seal bearing inserts shown on pages 88 to 90 can be fitted into these housings. The unit reference has a prefix 'T', e.g. TSLFL1.

Shaft diameter	RHP designation	Basic bearing group insert	Housing group	Dimensions					
				L	H	H ₂	J	N	A
mm inches				mm inches					
12 15 16 17 1/2 5/8	SLFL12 SLFL15 SLFL16 SLFL17 SLFL1/2 SLFL3/8	SLFL12EC SLFL15EC SLFL16EC SLFL17EC SLFL1/2EC SLFL3/8EC	1017 1	58,7 2-311	81,0 3-189	49,0 1-929	63,5 2-500	7,1 -280	6,7 -264
20 3/4	SLFL20 SLFL3/4	SLFL20A SLFL3/4A SLFL20EC SLFL3/4EC	1020 2	66,7 2-626	90,5 3-563	55,0 2-165	71,5 2-815	8,7 -343	7,7 -303
25 7/8 15/16 1	SLFL25 SLFL7/8 SLFL15/16 SLFL1	SLFL25A SLFL7/8A SLFL15/16A SLFL1A SLFL25EC SLFL7/8EC SLFL15/16EC SLFL1EC	1025 3	71,0 2-795	95,3 3-752	60,0 2-362	76,0 2-992	8,7 -343	8,7 -343
30 1 1/8 1 3/16 1 1/4	SLFL30 SLFL1 1/8 SLFL1 3/16 SLFL1 1/4	SLFL30A SLFL1 1/8A SLFL1 3/16A SLFL1 1/4A SLFL30EC SLFL1 1/8EC SLFL1 3/16EC SLFL1 1/4EC	1030 4	84,1 3-311	112,7 4-437	71,0 2-795	90,5 3-563	10,5 -413	9,0 -354
35 1 3/8 1 7/16	SLFL35 SLFL1 3/8 SLFL1 7/16	SLFL35A SLFL1 3/8A SLFL1 7/16A SLFL35EC SLFL1 3/8EC SLFL1 7/16EC	1035 5	93,8 3-693	122,8 4-835	81,0 3-189	100,0 3-937	11,0 -433	10,0 -394
40 1 1/2	SLFL40 SLFL1 1/2	SLFL40A SLFL1 1/2A SLFL40EC SLFL1 1/2EC	1040 6	100,0 3-937	148,0 5-827	90,0 3-543	119,0 4-685	13,9 -547	10,4 -409

A ₁	B	B ₁	B ₂	B ₃	s	s ₁	s ₂	d ₁	d ₂	Max. radial housing load	Rec.max. speed	Mass (approx.)
mm inches										newtons lbf	rev/min	kg lb
4,0 -157	27,38 1-078	-	28,54 1-124	-	11,55 -455	6,55 -258	-	24,21 -953	28,58 1-125	2670 600	3000	0,2 0,4
4,0 -157	30,96 1-219	25,77 1-015	30,92 1-217	43,62 1-717	12,75 -502	7,56 -298	17,12 -674	28,50 1-122	33,30 1-311	3110 700	3000	0,3 0-6
4,0 -157	34,11 1-343	27,35 1-077	30,92 1-217	44,40 1-748	14,32 -564	7,56 -298	17,49 -689	34,01 1-339	38,10 1-500	3560 800	2500	0,3 0-7
5,0 -197	38,10 1-500	31,21 1-229	35,68 1-405	48,42 1-906	15,93 -627	9,04 -356	18,32 -721	40,00 1-575	44,45 1-750	4890 1100	2500	0,5 1-2
5,0 -197	42,88 1-688	34,90 1-374	38,88 1-531	51,18 2-016	17,53 -690	9,55 -376	18,89 -744	46,69 1-838	55,58 2-188	6490	2000	0,65
7,0 -276	49,23 1-938	41,18 1-621	43,64 1-718	56,34 2-218	19,10 -752	11,05 -435	21,46 -845	52,70 2-075	60,30 2-374	7490	1700	1,1

A modified version of these units is available if a Protector is to be fitted, see page 102 for details.

LPB SERIES (ISO)

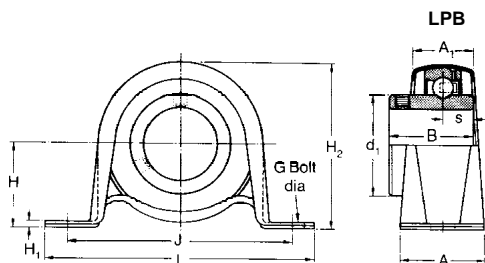

Note: these units are not re-greaseable.

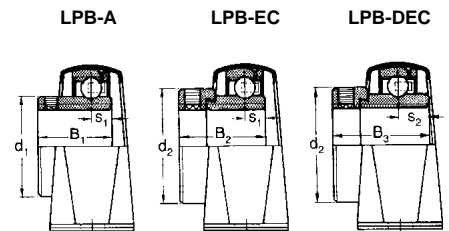

Shaft diameter		RHP designation		Basic bearing insert	Housing group	Dimensions					
						L	H	H ₁	H ₂	J	G
mm inches						mm inches					
12		LPB12	LPB12EC	1017	1	85,7	22,2	2,4	43,2	68,0	8
15		LPB15	LPB15EC			3-374	-874	-094	1-701	2-677	5/16
16		LPB16	LPB16EC								
17		LPB17	LPB17EC								
	1/2	LPB1 1/2	LPB1 1/2EC								
	5/8	LPB5/8	LPB5/8EC								
20		LPB20	LPB20EC	1020	2	98,4	25,4	2,4	49,9	76,0	8
	3/4	LPB3/4	LPB3/4EC			3-874	1-000	-094	1-965	2-992	5/16
25		LPB25	LPB25EC	1025	3	108,0	28,6	2,8	55,8	86,0	10
	7/8	LPB7/8	LPB7/8EC			4-252	1-126	-110	2-197	3-386	3/8
	15/16	LPB15/16	LPB15/16EC								
	1	LPB1	LPB1EC								
30		LPB30	LPB30EC	1030	4	117,5	33,3	3,6	65,7	95,0	10
	1 1/8	LPB1 1/8	LPB1 1/8EC			4-626	1-311	-142	2-587	3-740	3/8
	1 3/16	LPB1 3/16	LPB1 3/16EC								
	1 1/4	LPB1 1/4	LPB1 1/4EC								
35		LPB1 1/4L	LPB1 1/4ECL	1035	5	128,6	39,7	4,4	77,5	106,0	10
	1 1/4	LPB35	LPB35EC			5-063	1-563	-173	3-051	4-173	3/8
	1 3/8	LPB1 3/8	LPB1 3/8EC								
	1 7/16	LPB1 7/16	LPB1 7/16EC								

A	A ₁	B	B ₁	B ₂	B ₃	s	s ₁	s ₂	d ₁	d ₂	Max. radial downward radial load	Rec. max speed	Mass (approx.)
mm	mm	mm	mm	mm	mm	mm	mm	mm	mm	mm	newtons lbf	rev/ min	kg lb
inches	inches	inches	inches	inches	inches	inches	inches	inches	inches	inches			
25,4	15,9	27,38	-	28,54	-	11,55	6,55	-	24,21	28,58	1330	3000	0,2
1-000	-626	1-078	-	1-124	-	-455	-258	-	-953	1-125	300		0.4
31,7	21,6	30,96	25,77	30,92	43,62	12,75	7,56	17,12	28,50	33,30	1570	3000	0,2
1-248	-850	1-219	1-015	1-217	1-717	-502	-298	-674	1-122	1-311	350		0.5
31,7	21,6	34,11	27,35	30,92	44,40	14,32	7,56	17,49	34,01	38,10	1780	2500	0,3
1-248	-850	1-343	1-077	1-217	1-748	-564	-298	-689	1-339	1-500	400		0.7
37,5	25,5	38,10	31,21	35,68	48,42	15,93	9,04	18,32	40,00	44,45	2670	2500	0,5
1-476	1-004	1-500	1-229	1-405	1-906	-627	-356	-721	1-575	1-750	600		1-1
41,0	28,4	42,88	34,90	38,88	51,18	17,53	9,55	18,89	46,69	55,58	3560	2000	0,9
1-614	1-118	1-688	1-374	1-531	2-015	-690	-376	-744	1-838	2-188	800		1.9

LPBR SERIES

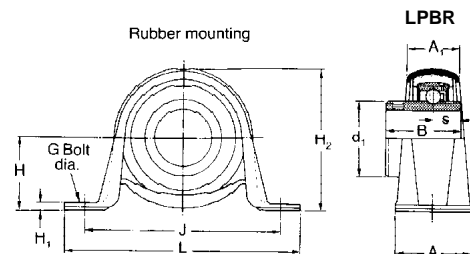

Note: these units are not re-greaseable.

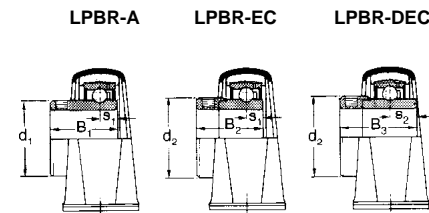

Shaft diameter	RHP designation	Basic bearing insert	Housing group	Dimensions						
				L	H	H ₁	H ₂	J	G	
mm inches				mm inches						
12 15 16 17	LPBR12 LPBR15 LPBR16 LPBR17	LPBR12EC LPBR15EC LPBR16EC LPBR17EC	1017	2	98,4 3-874	25,4 1-000	2,4 -094	49,9 1-965	76,0 2-992	8 5/16
20	LPBR20 LPBR20A LPBR20A	LPBR20EC LPBR20EC LPBR20A	1020	3	108,0 4-252	28,6 1-126	2,8 -110	55,8 2-197	86,0 3-386	10 3/8
25	LPBR25 LPBR25A LPBR25A	LPBR25EC LPBR25EC LPBR25A	1025	4	117,5 4-626	33,3 1-311	3,6 -142	65,7 2-587	95,0 3-740	10 3/8
30	LPBR30 LPBR30A LPBR30A	LPBR30EC LPBR30EC LPBR30A	1030	5	128,6 5-063	39,7 1-563	4,4 -173	77,5 3-051	106,0 4-173	10 3/8

A	A ₁	B	B ₁	B ₂	B ₃	s	s ₁	s ₂	d ₁	d ₂	Max. downward radial load	Rec. max. speed	Mass (approx.)
mm inches											newtons lbf	rev/min	kg lb
31,7 1-248	21,6 -850	27,38 1-078	-	28,54 1-124	-	11,55 -455	6,55 -258	-	24,21 -953	28,58 1-125	890 200	3000	0,2 0,5
31,7 1-248	21,6 -850	30,96 1-219	25,77 1-015	30,92 1-217	43,62 1-717	12,75 -502	7,56 -298	17,12 -674	28,50 1-122	33,30 1-311	1110 250	3000	0,3 0,7
37,5 1-476	25,5 1-004	34,11 1-343	27,35 1-077	30,92 1-217	44,40 1-748	14,32 -564	7,56 -298	17,49 -689	34,01 1-339	38,10 1-500	1330 300	2500	0,5 1-1
41,0 1-614	28,4 1-118	38,10 1-500	31,21 1-229	35,68 1-405	48,42 1-906	15,93 -627	9,04 -356	18,32 -721	40,00 1-575	44,45 1-750	1560 350	2500	0,9 1,9

1000DECG AND 1100DEC SERIES (ISO)

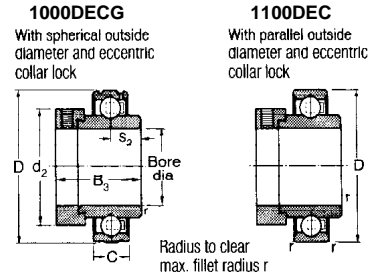

Shaft diameter	RHP designation		Dimensions						ISO load ratings		Rec. max. speed	Mass (approx.)
	1000DECG series	1100DEC series	D	C	B ₃	s ₂	d ₂	r	C _r	C _{or}		
mm inches			mm inches						newtons lbf	newtons lbf	rev/min	kg lb
20 3/4	1020-20DECG 1020-3/4DECG	1120-20DEC 1120-3/4DEC	47,000 1-8504	14,00 -551	43,62 1-717	17,12 -674	33,30 1-311	1,00 -039	12800 2880	6580 1480	7450	0,20 -44
25 7/8 15/16 1	1025-25DECG 1025-7/8DECG 1025-15/16DECG 1025-1DEC	1125-25DEC 1125-7/8DEC 1125-15/16DEC 1125-1DEC	52,000 2-0472	15,00 -591	44,40 1-748	17,49 -689	38,10 1-500	1,00 -039	14000 3150	7880 1770	6250	0,26 -57
30 1 1/8 1 3/16 1 1/4	1030-30DECG 1030-1 1/8DECG 1030-1 3/16DECG 1030-1 1/4DECG	1130-30DEC 1130-1 1/8DEC 1130-1 3/16DEC 1130-1 1/4DEC	62,000 2-4409	16,00 -630	48,42 1-906	18,32 -721	44,45 1-750	1,00 -039	19500 4380	11300 2540	5300	0,53 1-17
35 1 1/4 1 3/8 1 7/16	1035-35DECG 1035-1 1/4DECG 1035-1 3/8DECG 1035-1 7/16DECG	1135-35DEC 1135-1 1/4DEC 1135-1 3/8DEC 1135-1 7/16DEC	72,000 2-8346	17,00 -669	51,18 2-015	18,89 -744	55,58 2-188	1,00 -039	25700 5780	15300 3440	4500	0,70 1-54
40 1 1/2	1040-40DECG 1040-1 1/2DECG	1140-40DEC 1140-1 1/2DEC	80,000 3-1496	18,00 -709	56,34 2-218	21,46 -845	60,30 2-374	1,00 -039	29100 6540	17900 4020	4000	0,82 1-81
45 1 5/8 1 11/16 1 3/4	1045-45DECG 1045-1 5/8DECG 1045-1 11/16DECG 1045-1 3/4DECG	1145-45DEC 1145-1 5/8DEC 1145-1 11/16DEC 1145-1 3/4DEC	85,000 3-3465	19,00 -748	56,34 2-218	21,46 -845	63,50 2-500	1,00 -039	32500 7310	20500 4610	3700	1,08 2-38
50 1 7/8 1 15/16	1050-50DECG 1050-1 7/8DECG 1050-1 15/16DECG	1150-50DEC 1150-1 7/8DEC 1150-1 15/16DEC	90,000 3-5433	20,00 -787	62,70 2-469	24,65 -970	69,85 2-750	1,00 -039	35000 7870	23200 5220	3400	1,19 2-62
55 2 1/8 2 1/16	1055-55DECG 1055-2 1/8DECG 1055-2 1/16DECG	1155-55DEC 1155-2 1/8DEC 1155-2 1/16DEC	100,000 3-9370	21,00 -827	71,44 2-813	27,82 1-095	76,20 3-000	1,50 -059	43500 9780	29200 6560	3100	1,40 3-09
60 2 1/4 2 3/8 2 7/16 2 1/2	1060-60DECG 1060-2 1/4DECG 1060-2 3/8DECG 1060-2 7/16DECG 1065-2 1/2DECG	1160-60DEC 1160-2 1/4DEC 1160-2 3/8DEC 1160-2 7/16DEC 1165-2 1/2DEC	110,000 4-3307	22,00 -866	77,82 3-064	31,02 1-221	84,12 3-312	1,50 -059	52500 11800	35900 8070	2800	1,72 3-79
65 2 1/2 2 5/8 2 11/16	1070-65DECG 1070-2 1/2DECG 1070-2 5/8DECG 1070-2 11/16DECG	1170-65DEC 1170-2 1/2DEC 1170-2 5/8DEC 1170-2 11/16DEC	125,000 4-9213	24,00 -945	85,36 3-361	34,19 1-346	96,82 3-812	1,50 -059	62000 13940	44000 9890	2450	2,56 5-64
65 2 11/16 70 2 3/4 75 2 7/8 2 15/16	1075-65DECG 1075-70DECG 1075-75DECG 1075-2 11/16DECG 1075-2 3/4DECG 1075-2 7/8DECG 1075-2 15/16DECG	1175-65DEC 1175-70DEC 1175-75DEC 1175-2 11/16DEC 1175-2 3/4DEC 1175-2 7/8DEC 1175-2 15/16DEC	130,000 5-1181	25,00 -984	91,72 3-611	37,37 1-471	101,60 4-000	1,50 -059	66000 14840	49300 11080	2300	2,94 6-48

1200G AND 1300 SERIES

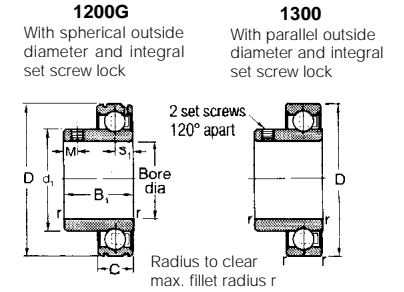

Shaft diameter	RHP designation		Dimensions						ISO load ratings		Rec. max. speed	Mass (approx.)	
	1200G series	1300 series	D	C	B ₁	s ₁	d ₁	M	r	C _r			C _{or}
mm inches			mm inches							newtons lbf	newtons lbf	rev/min	kg lb
20 3/4	1220-20G 1220-3/4G	1320-20 1320-3/4	47,000 1-8504	14,00 -551	25,77 1-015	7,56 -298	28,50 1-122	5,35 -211	1,00 -039	12800 2880	6580 1480	7450	0,10 -22
25 1	1225-25G 1225-1G	1325-25 1325-1	52,000 2-0472	15,00 -591	27,35 1-077	7,56 -298	34,01 1-339	5,35 -211	1,00 -039	14000 3150	7880 1770	6250	0,13 -29
30 1 1/4	1230-30G 1230-1 1/4G	1330-30 1330-1 1/4	62,000 2-4409	16,00 -630	31,21 1-229	9,04 -356	40,00 1-575	5,85 -230	1,00 -039	19500 4380	11300 2540	5300	0,32 -71
35 1 1/4	1235-35G 1235-1 1/4G	1335-35 1335-1 1/4	72,000 2-8346	17,00 -669	34,90 1-374	9,55 -376	46,69 1-838	7,35 -289	1,00 -039	25700 5780	15300 3440	4500	0,43 -95
40 1 1/2	1240-40G 1240-1 1/2G	1340-40 1340-1 1/2	80,000 3-1496	18,00 -709	41,18 1-621	11,05 -435	52,70 2-075	7,95 -313	1,00 -039	29100 6540	17900 4020	4000	0,54 1-19
45 1 3/4	1245-45G 1245-1 3/4G	1345-45 1345-1 3/4	85,000 3-3465	19,00 -748	41,18 1-621	11,05 -435	57,30 2-256	7,95 -313	1,00 -039	32500 7310	20500 4610	3700	0,61 1-34
50	1250-50G	1350-50	90,000 3-5433	20,00 -787	43,54 1-714	11,05 -435	62,20 2-449	8,95 -352	1,00 -039	35000 7870	23200 5220	3400	0,76 1-68

Please check availability.

**1200EC AND 1200ECG SERIES (ISO)
1300EC SERIES**

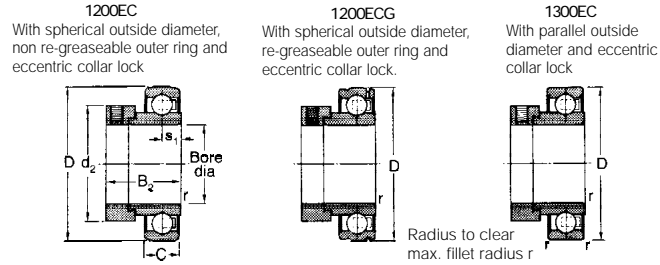

Shaft diameter	RHP designation			Dimensions							ISO load ratings		Rec. max. speed	Mass (approx.)	
	1200EC series	1200ECG series	1300EC series	D	C	B ₂	s ₁	d ₂	r	C _r	dynamic	static			
mm inches				mm inches								newtons lbf	newtons lbf	rev/min	kg lb
12	1217-12EC	1217-12ECG	1317-12EC	40,000	12,00	28,54	6,55	28,58	0,60	9550	4760	7000	0,15		
15	1217-15EC	1217-15ECG	1317-15EC	1-5748	-472	1-124	.258	1-125	.024	2150	1070		.33		
16	1217-16EC	1217-16ECG	1317-16EC												
17	1217-17EC	1217-17ECG	1317-17EC												
1/2	1217-1/2EC	1217-1/2ECG	1317-1/2EC												
5/8	1217-5/8EC	1217-5/8ECG	1317-5/8EC												
20	1220-20EC	1220-20ECG	1320-20EC	47,000	14,00	30,92	7,56	33,30	1,00	12800	6580	6700	0,16		
3/4	1220-3/4EC	1220-3/4ECG	1320-3/4EC	1-8504	-551	1-217	.298	1-311	.039	2880	1480		.35		
25	1225-25EC	1225-25ECG	1325-25EC	52,000	15,00	30,92	7,56	38,10	1,00	14000	7880	6250	0,23		
7/8	1225-7/8EC	1225-7/8ECG	1325-7/8EC	2-0472	-591	1-217	.298	1-500	.039	3150	1770		5.1		
15/16	1225-15/16EC	1225-15/16ECG	1325-15/16EC												
1	1225-1EC	1225-1ECG	1325-1EC												
30	1230-30EC	1230-30ECG	1330-30EC	62,000	16,00	35,68	9,04	44,45	1,00	19500	11300	5300	0,40		
1 1/8	1230-1 1/8EC	1230-1 1/8ECG	1330-1 1/8EC	2-4409	-630	1-405	.356	1-750	.039	4380	2540		.88		
1 3/16	1230-1 3/16EC	1230-1 3/16ECG	1330-1 3/16EC												
1 1/4	1230-1 1/4EC	1230-1 1/4ECG	1330-1 1/4EC												
35	1235-35EC	1235-35ECG	1335-35EC	72,000	17,00	38,88	9,55	55,58	1,00	25700	15300	4500	0,58		
1 1/4	1235-1 1/4EC	1235-1 1/4ECG	1335-1 1/4EC	2-8346	-669	1-531	.376	2-188	.039	5780	3440		1.28		
1 3/8	1235-1 3/8EC	1235-1 3/8ECG	1335-1 3/8EC												
1 7/16	1235-1 7/16EC	1235-1 7/16ECG	1335-1 7/16EC												
40	1240-40EC	1240-40ECG	1340-40EC	80,000	18,00	43,64	11,05	60,30	1,00	29100	17900	4000	0,73		
1 1/2	1240-1 1/2EC	1240-1 1/2ECG	1340-1 1/2EC	3-1496	-709	1-718	.435	2-374	.039	6540	4020		1.61		
45	1245-45EC	1245-45ECG	1345-45EC	85,000	19,00	43,64	11,05	63,50	1,00	32500	20500	3700	0,87		
1 5/8	1245-1 5/8EC	1245-1 5/8ECG	1345-1 5/8EC	3-3465	-748	1-718	.435	2-500	.039	7310	4610		1.92		
1 11/16	1245-1 11/16EC	1245-1 11/16ECG	1345-1 11/16EC												
1 3/4	1245-1 3/4EC	1245-1 3/4ECG	1345-1 3/4EC												
50	1250-50EC	1250-50ECG	1350-50EC	90,000	20,00	43,64	11,05	69,84	1,00	35000	23200	3400	0,98		
1 7/8	1250-1 7/8EC	1250-1 7/8ECG	1350-1 7/8EC	3-5433	-787	1-718	.435	2-750	.039	7870	5220		2.16		
1 15/16	1250-1 15/16EC	1250-1 15/16ECG	1350-1 15/16EC												
2	1250-2EC	1250-2ECG	1350-2EC												

1100CG SERIES

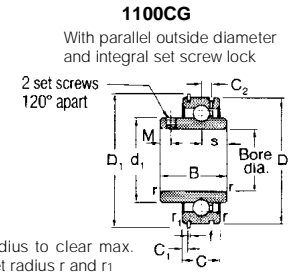

Shaft diameter	RHP designation 1100CG series	Dimensions														ISO load ratings		Rec. max. speed	Mass (approx.)
		D	D ₁	C	C ₁	C ₂	B	s	d ₁	f	M	r	r ₁	dynamic	static				
mm inches		mm inches														newtons lbf	newtons lbf	rev/min	kg lb
20	1120-20CG 1120-3/4CG	47,000	52,68	15,88	2,39	4,17	30,96	12,75	28,50	1,12	5,35	1,00	0,50	12800	6580	6700	0,23		
		1-8504	2-074	-625	-.094	-.164	1-219	-.502	1-122	-.044	-.211	-.039	-.020	2880	1480		.50		
25	1125-25CG 1125-7/8CG 1125-15/16CG 1125-1CG	52,000	57,81	19,05	2,39	4,39	34,11	14,32	34,01	1,12	5,35	1,00	0,50	14000	7880	6250	0,31		
		2-0472	2-276	-.750	-.094	-.173	1-343	-.564	1-339	-.044	-.211	-.039	-.020	3150	1770		.68		
30	1130-30CG 1130-1 1/8CG 1130-1 3/16CG	62,000	67,69	22,22	3,18	5,10	38,10	15,93	40,00	1,70	5,85	1,00	0,50	19500	11300	5300	0,42		
		2-4409	2-665	-.875	-.125	-.201	1-500	-.627	1-575	-.067	-.230	-.039	-.020	4380	2540		.93		
35	1135-35CG 1135-1 1/4CG 1135-1 3/8CG 1135-1 7/16CG	72,000	78,51	23,81	3,18	5,61	42,88	17,53	46,69	1,70	7,35	1,00	1,00	25700	15300	4500	0,61		
		2-8346	3-091	-.937	-.125	-.221	1-688	-.690	1-838	-.067	-.289	-.039	-.039	5780	3440		1.35		
40	1140-40CG 1140-1 1/2CG	80,000	86,51	27,78	3,18	6,22	49,23	19,10	52,70	1,70	7,95	1,00	1,00	29100	17900	4000	0,91		
		3-1496	3-406	1-094	-.125	-.245	1-938	-.752	2-075	-.067	-.313	-.039	-.039	6540	4020		2.00		
45	1145-45CG 1145-1 5/8CG 1145-1 11/16CG 1145-1 3/4CG	85,000	91,51	27,78	3,18	6,52	49,23	19,10	57,30	1,70	7,95	1,00	1,00	32500	20500	3700	1,05		
		3-3465	3-603	1-094	-.125	-.257	1-938	-.752	2-256	-.067	-.313	-.039	-.039	7310	4610		2.31		
50	1150-1 7/8CG 1150-1 15/16CG	90,000	96,49	28,58	3,18	6,72	51,59	19,10	62,20	2,46	8,95	1,00	1,00	35000	23200	3400	1,10		
		3-5433	3-799	1-125	-.125	-.265	2-031	-.752	2-449	-.097	-.352	-.039	-.039	7870	5220		2.43		

1000-KG AND 1100-K SERIES

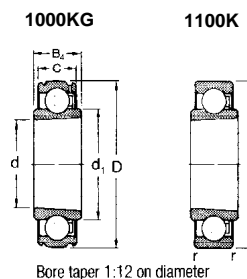
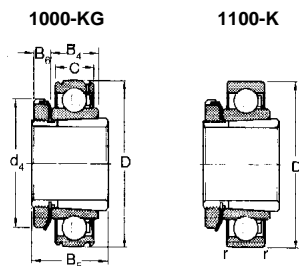

Shaft diameter		RHP designation		sleeve, nut & lockwasher assembly only	bearing insert without sleeve, nut & lockwasher series	Dimensions							
		1000-KG series	1100-K series			D	C	B ₄	B ₅	B ₆	d		
mm	inches					mm	inches						
20	3/4	1025-20KG 1025-3/4KG	1125-20K 1125-3/4K	H305 HE305-3/4	1025KG 1125K	52,000 2.0472	15,00 .591	19,00 .748	29,00 1.142	8,00 .315	25,000 .9843		
25	15/16 1	1030-25KG 1030-15/16KG 1030-1KG	1130-25K 1130-15/16K 1130-1K	H306 HE306-15/16 HE306-1	1030KG 1130K	62,000 2.4409	16,00 .630	20,00 .787	31,00 1.220	8,00 .315	30,000 1.1811		
30	11/8 13/16	1035-30KG 1035-11/8KG 1035-13/16KG	1135-30K 1135-11/8K 1135-13/16K	H307 HE307-11/8 HE307-13/16	1035KG 1135K	72,000 2.8346	17,00 .669	21,00 .827	35,00 1.378	9,00 .354	35,000 1.3780		
35	11/4 13/8	1040-35KG 1040-11/4KG 1040-13/8KG	1140-35K 1140-11/4K 1140-13/8K	H308 HE308-11/4 HE308-13/8	1040KG 1140K	80,000 3.1496	18,00 .709	22,00 .866	36,00 1.417	10,00 .394	40,000 1.5748		
40	17/16 1 1/2	1045-40KG 1045-17/16KG 1045-1 1/2KG	1145-40K 1145-17/16K 1145-1 1/2K	H309 HE309-17/16 HE309-1 1/2	1045KG 1145K	85,000 3.3465	19,00 .748	23,00 .906	39,00 1.535	11,00 .433	45,000 1.7717		
45	11 1/16 1 3/4	1050-45KG 1050-11 1/16KG 1050-1 3/4KG	1150-45K 1150-11 1/16K 1150-1 3/4K	H310 HE310-11 1/16 HE310-1 3/4	1050KG 1150K	90,000 3.5433	20,00 .787	24,00 .945	42,00 1.654	12,00 .472	50,000 1.9685		
50	11 5/16 2	1055-50KG 1055-11 5/16KG 1055-2KG	1155-50K 1155-11 5/16K 1155-2K	H311 HE311-11 5/16 HE311-2	1055KG 1155K	100,000 3.9370	21,00 .827	25,00 .984	45,00 1.772	12,00 .472	55,000 2.1654		

d ₁	d ₄	r	ISO load ratings		Rec. max. speed	Mass (approx.)
			dynamic C _r	static C _{0r}		
mm	inches		newtons	newtons	rev/min	kg
inches			lbf	lbf		lb
34.01	38.00	1.00	14000	7880	6250	0.20
1.339	1.496	.039	3150	1770		0.44
40.000	45.00	1.00	19500	11300	5300	0.30
1.575	1.772	.039	4380	2540		0.67
46.69	52.00	1.00	25700	15300	4500	0.42
1.838	2.047	.039	5780	3440		0.92
52.70	58.00	1.00	29100	17900	4000	0.54
2.075	2.283	.039	6540	4020		1.19
57.30	65.00	1.00	32500	20500	3700	0.64
2.256	2.559	.039	7310	4610		1.42
62.20	70.00	1.00	35000	23200	3400	0.75
2.449	2.756	0.39	7870	5220		1.65
68.81	75.00	1.50	43500	29200	3100	0.95
2.709	2.953	.059	9780	6560		2.10

T1000G SERIES

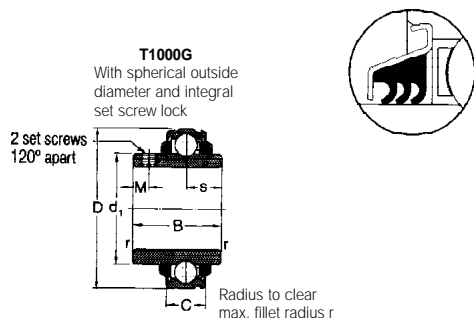

Shaft diameter	RHP designation	Dimensions							ISO load ratings		Rec. max. speed	Mass (approx.)
		D	C	B	s	d ₁	M	r	dynamic C _r	static C _{0r}		
mm inches		mm inches							newtons lbf	newtons lbf	rev/min	kg lb
25	T1025-25G T1025-7/8G T1025-15/16G T1025-1G	52,000 2.0472	15,00 .591	34,11 1.343	14,32 .564	34,01 1.339	5,35 .211	1,00 .039	14000 3150	7880 1770	1000	0,17 .38
25 30	T1030-25G T1030-30G T1030-7/8G T1030-1G T1030-11/8G T1030-13/16G T1030-11/4G	62,000 2.4409	18,00 .709	38,10 1.500	15,93 .627	40,00 1.575	5,85 .230	1,0 .039	19500 4380	11300 2540	850	0,37 .81
30 35	T1035-30G T1035-35G T1035-13/16G T1035-11/4G T1035-13/8G T1035-17/16G	72,000 2.8346	19,00 .748	42,88 1.688	17,53 .690	46,69 1.838	7,35 .289	1,00 .039	25700 5780	15300 3440	750	0,51 1.12
35 40	T1040-35G T1040-40G T1040-13/8G T1040-17/16G T1040-11/2G	80,000 3.1496	21,00 .827	49,23 1.938	19,10 .752	52,70 2.075	7,95 .313	1,00 .039	29100 6540	17900 4020	650	0,64 1.41
40 45	T1045-40G T1045-45G T1045-11/2G T1045-15/8G T1045-111/16G T1045-13/4G	85,000 3.3465	22,00 .866	49,23 1.938	19,10 .752	57,30 2.256	7,95 .313	1,00 .039	32500 7310	20500 4610	600	0,73 1.62
45 50	T1050-45G T1050-50G T1050-111/16G T1050-13/4G T1050-17/8G T1050-115/16G T1050-2G	90,000 3.5433	23,00 .906	51,59 2.031	19,10 .752	62,20 2.449	8,95 .352	1,00 .039	35000 7870	23200 5220	550	0,91 2.00
50 55	T1055-50G T1055-55G T1055-17/8G T1055-119/16G T1055-2G T1055-21/8G T1055-23/16G	100,000 3.9370	25,00 .984	55,55 2.187	22,28 .877	68,81 2.709	9,55 .376	1,50 .059	43500 9780	29200 6560	500	1,12 2.47

Please check availability.

Shaft diameter	RHP designation	Dimensions							ISO load ratings		Rec. max. speed	Mass (approx.)
		D	C	B	s	d ₁	M	r	dynamic C _r	static C _{0r}		
mm inches		mm inches							newtons lbf	newtons lbf	rev/min	kg lb
55 60	T1060-55G T1060-60G T1060-23/16G T1060-21/4G T1060-23/8G T1060-27/16G	110,000 4.3307	25,00 .984	65,07 2.562	25,45 1.002	75,34 2.966	9,55 .376	1,50 .059	52500 11800	35900 8070	450	1,50 3.30
60 65 70	T1070-60G T1070-65G T1070-70G T1070-27/16G T1070-21/2G T1070-25/8G T1070-211/16G	125,000 4.9213	28,00 1.102	74,63 2.938	30,23 1.190	87,00 3.425	12,15 .478	1,50 .059	62000 13940	44000 9890	400	2,30 5.07
75 80	T1080-75G T1080-80G T1080-215/16G T1080-3G	140,000 5.5118	30,00 1.181	82,55 3.250	33,37 1.314	98,50 3.878	11,15 .439	2,00 .079	72500 16300	53000 11910	345	3,27 7.20

T1000DECG SERIES

T1000DECG
With spherical outside diameter and eccentric collar lock

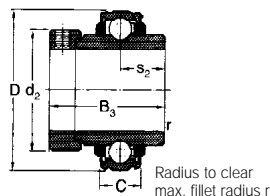
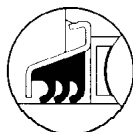

Shaft diameter	RHP designation	Dimensions							ISO load ratings		Rec. max. speed	Mass (approx.)
		D	C	B ₃	s ₂	d ₂	r	C _r	C _{or}			
mm inches		mm inches						newtons lbf	newtons lbf	rev/min	kg lb	
25 7/8 15/16 1	T1025-25DECG T1025-7/8DECG T1025-15/16DECG T1025-1DECG	52,000 2-0472	15,00 -591	44,40 1-748	17,49 -689	38,10 1-500	1,00 -039	14000 3150	7880 1770	1000	0,26 -57	
30 1 1/8 1 3/16 1 1/4	T1030-30DECG T1030-1 1/8DECG T1030-1 3/16DECG T1030-1 1/4DECG	62,000 2-4409	18,00 -709	48,42 1-906	18,32 -721	44,45 1-750	1,00 -039	19500 4380	11300 2540	850	0,53 1-17	
35 1 1/4 1 3/8 1 7/16	T1035-35DECG T1035-1 1/4DECG T1035-1 3/8DECG T1035-1 7/16DECG	72,000 2-8346	19,00 -748	51,18 2-015	18,89 -744	55,58 2-188	1,00 -039	25700 5780	15300 3440	750	0,70 1-54	
40 1 1/2	T1040-40DECG T1040-1 1/2DECG	80,000 3-1496	21,00 -827	56,34 2-218	21,46 -845	60,30 2-374	1,00 -039	29100 6540	17900 4020	650	0,82 1-81	
45 1 5/8 1 11/16 1 3/4	T1045-45DECG T1045-1 5/8DECG T1045-1 11/16DECG T1045-1 3/4DECG	85,00 3-3465	22,00 -866	56,34 2-218	21,46 -845	63,50 2-500	1,00 -039	32500 7310	20500 4610	600	1,08 2-38	
50 1 7/8 1 5/16	T1050-50DECG T1050-1 7/8DECG T1050-1 5/16DECG	90,000 3-5433	23,00 -906	62,70 2-469	24,65 -970	69,85 2-750	1,00 -039	35000 7870	23200 5220	550	1,19 2-62	
55 2 2 1/8 2 3/16	T1055-55DECG T1055-2DECG T1055-2 1/8DECG T1055-2 3/16DECG	100,000 3-9370	25,00 -984	71,44 2-813	27,82 1-095	76,20 3-000	1,50 -059	43500 9780	29200 6560	500	1,40 3-09	
60 2 1/4 2 1/16	T1060-60DECG T1060-2 1/4DECG T1060-2 1/16DECG	110,000 4-3307	25,00 -984	77,82 3-064	31,02 1-221	84,12 3-312	1,5 -059	52500 11800	35900 8070	450	1,81 4-00	
65 70	T1070-65DECG T1070-70DECG	125,000 4-9213	28,00 1-102	85,36 3-361	34,19 1-346	96,82 3-812	1,5 -059	62000 13940	44000 9890	400	2,49 5-50	
80	T1080-80DECG	140,000 5-5118	30,00 1-181	99,95 3-935	40,53 1-596	111,12 4-375	2,0 -079	72500 16300	53000 11910	350	3,54 7-80	

Please check availability.

1000GFS SERIES

1000GFS
With spherical outside diameter and integral set screw lock

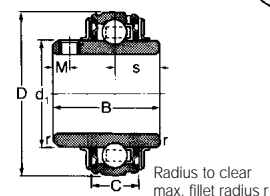
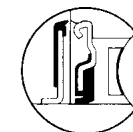

Shaft diameter	RHP designation	Dimensions							ISO load ratings		Rec. max. speed	Mass (approx.)
		D	C	B	s	d ₁	M	r	C _r	C _{or}		
mm inches		mm inches						newtons lbf	newtons lbf	rev/min	kg lb	
25 7/8 15/16 1	1025-25GFS 1025-7/8GFS 1025-15/16GFS 1025-1GFS	52,000 2-0472	15,00 -591	34,11 1-343	14,32 -564	34,01 1-339	5,35 -211	14000 3150	7880 1770	6250	0,17 -38	
25 30 7/8 1 1 1/8 1 3/16 1 1/4	1030-25GFS 1030-30GFS 1030-7/8GFS 1030-1GFS 1030-1 1/8GFS 1030-1 3/16GFS 1030-1 1/4GFS	62,000 2-4409	16,00 -630	38,10 1-500	15,93 -627	40,00 1-575	5,85 -230	19500 4380	11300 2540	5300	0,37 -81	
30 35 1 3/16 1 1/4 1 5/16 1 3/8 1 7/16	1035-30GFS 1035-35GFS 1035-1 3/16GFS 1035-1 1/4GFS 1035-1 5/16GFS 1035-1 3/8GFS 1035-1 7/16GFS	72,000 2-8346	17,00 -669	42,88 1-688	17,53 -690	46,69 1-838	7,35 -289	25700 5780	15300 3440	4500	0,51 1-12	
35 40 1 3/8 1 7/16 1 1/2	1040-35GFS 1040-40GFS 1040-1 3/8GFS 1040-1 7/16GFS 1040-1 1/2GFS	80,000 3-1496	18,00 -709	49,23 1-938	19,10 -752	52,70 2-075	7,95 -313	29100 6540	17900 4020	4000	0,64 1-41	
40 45 1 1/2 1 5/8 1 11/16 1 3/4	1045-40GFS 1045-45GFS 1045-1 1/2GF 1045-1 5/8GFS 1045-1 11/16GFS 1045-1 3/4GFS	85,000 3-3465	19,00 -748	49,23 1-938	19,10 -752	57,30 2-256	7,95 -313	32500 7310	20500 4610	3700	0,73 1-62	
45 50 1 11/16 1 3/4 1 7/8 1 5/16 2	1050-45GFS 1050-50GFS 1050-1 11/16GFS 1050-1 3/4GFS 1050-1 7/8GFS 1050-1 5/16GFS 1050-2GFS	90,000 3-5433	20,00 -787	51,59 2-031	19,10 -752	62,20 2-449	8,95 -352	35000 7870	23200 5220	3400	0,91 2-00	
50 55 1 7/8 1 5/16 2 2 1/8 2 3/16	1055-50GFS 1055-55GFS 1055-1 7/8GFS 1055-1 5/16GFS 1055-2GFS 1055-2 1/8GFS 1055-2 3/16GFS	100,000 3-9370	21,00 -827	55,55 2-187	22,28 -877	68,81 2-709	9,55 -376	43500 9780	29200 6560	3100	1,12 2-47	
55 60 2 3/16 2 1/4 2 3/8 2 7/16	1060-55GFS 1060-60GFS 1060-2 3/16GFS 1060-2 1/4GFS 1060-2 3/8GFS 1060-2 7/16GFS	110,000 4-3307	22,00 -866	65,07 2-562	25,45 1-002	75,34 2-966	9,55 -376	52500 11800	35900 8070	2800	1,47 3-25	

Please check availability.

1000DECGFS SERIES

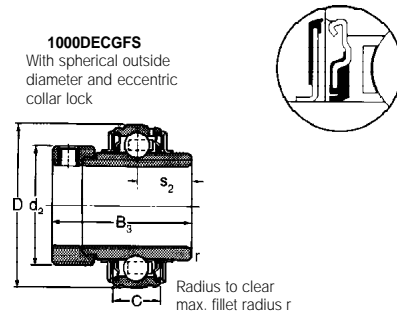

Shaft diameter	RHP designation	Dimensions						ISO load ratings		Rec. max. speed	Mass (approx.)
		D	C	B ₃	s ₂	d ₂	r	dynamic C _r	static C _{0r}		
mm inches		mm inches						newtons lbf	newtons/lbf	rev/min	kg lb
25 7/8 15/16 1	1025-25DECGFS 1025-7/8DECGFS 1025-15/16DECGFS 1025-1DECGFS	52,000 2.0472	15,00 -591	44,40 1.748	17,49 -689	38,10 1.500	1,00 -039	14000 3150	7880 1770	6250	0,26 -57
30 11/8 13/16 11/4	1030-30DECGFS 1030-11/8DECGFS 1030-13/16DECGFS 1030-11/4DECGFS	62,000 2.4409	16,00 -630	48,42 1.906	18,32 -721	44,45 1.750	1,00 -039	19500 4380	11300 2540	5300	0,53 1.17
35 11/4 15/16 13/8 17/16	1035-35DECGFS 1035-11/4DECGFS 1035-15/16DECGFS 1035-13/8DECGFS 1035-17/16DECGFS	72,000 2.8346	17,00 -669	51,18 2.015	18,89 -744	55,58 2.188	1,00 -039	25700 5780	15300 3440	4500	0,70 1.54
40 11/2	1040-40DECGFS 1040-11/2DECGFS	80,000 3.1496	18,00 -709	56,34 2.218	21,46 -845	60,30 2.374	1,00 -039	29100 6540	17900 4020	4000	0,82 1.81
45 15/8 111/16 13/4	1045-45DECGFS 1045-15/8DECGFS 1045-111/16DECGFS 1045-13/4DECGFS	85,000 3.3465	19,00 -748	56,34 2.218	21,46 -845	63,50 2.500	1,00 -039	32500 7310	20500 4610	3700	1,08 2.38
50 17/8 15/16	1050-50DECGFS 1050-17/8DECGFS 1050-15/16DECGFS	90,000 3.5433	20,00 -787	62,70 2.469	24,65 -970	69,85 2.750	1,00 -039	35000 7870	23200 5220	3400	1,19 2.62
55 2 21/8 23/16	1055-55DECGFS 1055-2DECGFS 1055-21/8DECGFS 1055-23/16DECGFS	100,000 3.9370	21,00 -827	71,44 2.813	27,82 1.095	76,20 3.000	1,50 -059	43500 9780	29200 6560	3100	1,40 3.09
60 21/4 23/8 27/16 21/2	1060-60DECGFS 1060-21/4DECGFS 1060-23/8DECGFS 1060-27/16DECGFS 1060-21/2DECGFS	110,000 4.3307	22,00 -866	77,82 3.064	31,02 1.221	84,12 3.312	1,50 -059	52500 11800	35900 8070	2800	1,72 3.79

Please check availability.

1726200-2RS SERIES
AND 1726300-2RS SERIES

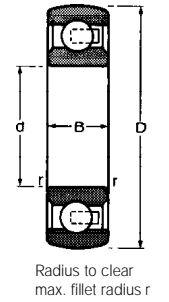

RHP designation	Dimensions				ISO load ratings		Axial load factor f _o	Rec. max. speed	Mass (approx.)
	d	D	B	r	dynamic C _r	static C _{0r}			
	mm inches				newtons lbf	newtons lbf		rev/min	kg lb
1726203-2RS	17,000 -6693	40,000 1.5748	12,00 -472	0,60 -024	9550 2150	4760 1070	13,1	12500	0,06 0.14
1726204-2RS	20,000 -7874	47,000 1.8504	14,00 -551	1,00 -039	12800 2880	6580 1480	13,1	14000	0,10 0.22
1726205-2RS	25,000 -9843	52,000 2.0472	15,00 -591	1,00 -039	14000 3150	7880 1770	13,9	9800	0,12 0.27
1726206-2RS	30,000 1.1811	62,000 2.4409	16,00 -630	1,00 -039	19500 4380	11300 2540	13,8	8200	0,20 0.43
1726207-2RS	35,000 1.3780	72,000 2.8346	17,00 -669	1,00 -039	25700 5780	15300 3440	13,8	7100	0,28 0.61
1726208-2RS	40,000 1.5748	80,000 3.1496	18,00 -709	1,00 -039	29100 6540	17400 4020	14,0	6300	0,35 0.77
1726209-2RS	45,000 1.7717	85,000 3.3465	19,00 -748	1,00 -039	32500 7310	20500 4610	14,1	5900	0,40 0.87
1726210-2RS	50,000 1.9685	90,000 3.5433	20,00 -787	1,00 -039	35000 7870	23200 5220	14,4	5500	0,5 1.0
1726308-2RS	40,000 1.5748	90,000 3.5433	23,00 -906	1,50 -059	40500 9100	23900 5370	13,2	5900	0,6 1.3
1726309-2RS	45,000 1.7717	100,000 3.9370	25,00 -984	1,50 -059	53000 11900	31700 7130	13,0	5300	0,8 1.8
1726310-2RS	50,000 1.9685	110,000 4.3307	27,00 1.063	2,00 -079	62000 13940	37900 8520	13,0	4800	1,1 2.4

1726200-2RS series only:

These bearings can be supplied fitted into standard housings and pressings. To obtain the unit designation add the 'bearing bore' and '2RS' to the housing series reference, e.g. NP25-2RS.

For bore and outside dia. Tolerances see page 22.

Please check availability.

PDF and DNF Series
PDF and DF Series

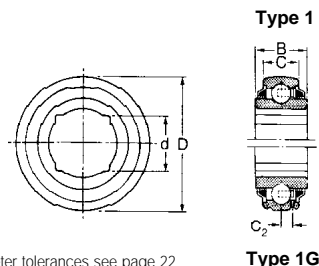

Note: For outer ring outside diameter tolerances see page 22

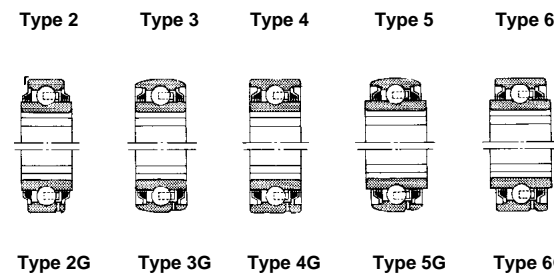

Square shaft	RHP designation	Type	Dimensions				
			square bore		outside diameter		
	spherical outside diameter	parallel outside diameter	d nominal	tolerance nominal to minus	D nominal	B	C
mm inches			mm inches				
7/8	2/DNF240/7	1	23.09	0.20	80,000	36.51	18.00
7/8	PDFNF240/7Y	5	23.09	0.20	80,000	36.51	30.16
1	DNF140/8Y	1	26.30	0.20	80,000	30.16	21.00
1	DNF240/8Y	1	26.30	0.20	80,000	36.51	21.00
1	2/DNF240/8	1	26.30	0.20	80,000	36.51	18.00
1	DF140/8Y	2	26.30	0.20	80,000	30.16	21.00
1	DF240/8Y	2	26.30	0.20	80,000	36.51	21.00
1	2/DF240/8	2	26.30	0.20	80,000	36.51	18.00
1	PDFNF240/8Y	5	26.30	0.20	80,000	36.51	30.16
1	1/PDNF240/8G	5G	26.30	0.20	80,000	36.51	24.00
1	PDF240/8Y	6	26.30	0.20	80,000	36.51	30.16
1 1/8	DNF140/9	1	29.44	0.20	80,000	30.16	21.00
1 1/8	DNF240/9Y	1	29.44	0.20	80,000	36.51	21.00
1 1/8	2/DNF240/9	1	29.44	0.20	80,000	36.51	18.00
1 1/8	DF140/9Y	2	29.44	0.20	80,000	30.16	21.00
1 1/8	2/DF240/9	2	29.44	0.20	80,000	36.51	18.00
1 1/8	PDFNF240/9Y	5	29.44	0.20	80,000	36.51	30.16
1 1/8	PDFNF240/9GY	5G	29.44	0.20	80,000	36.51	30.16
1 1/8	1/PDNF240/9G	5G	29.44	0.20	80,000	36.51	24.00
1 1/8	PDF240/9Y	6	29.44	0.20	80,000	36.51	30.16
1 1/8	DNF145/9Y	1	29.44	0.20	85,000	30.16	22.00
1 1/8	PDFNF145/9Y	3	29.44	0.20	85,000	30.16	30.16
1 1/8	PDFNF245/9Y	5	29.44	0.20	85,000	36.51	30.16
1 1/8	PDFNF150/9Y	3	29.44	0.20	90,000	30.16	30.16

C2	r	ISO load ratings		Rec. max speed	Mass (approx.)	Interchange data		
		dynamic Cr	static Cor			Fafnir	BCA	NDH
mm inches		newtons lbf	newtons lbf	rev/min	kg lb			
-	-	29100	17900	650	0.74	W208PPB13	DS208TT13	AS4508FF
-	-	6540	4020	-	1.62	-	-	-
-	-	29100	17900	650	0.89	-	-	-
-	-	6540	4020	-	1.96	-	-	-
-	-	29100	17900	650	0.63	-	-	-
-	-	6540	4020	-	1.39	-	-	-
-	-	29100	17900	650	0.69	-	-	-
-	-	6540	4020	-	1.52	-	-	-
-	-	29100	17900	650	0.62	W208PPB6	DS208TT6	AS4508BK
-	-	6540	4020	-	1.37	-	-	-
-	1.00	29100	17900	650	0.63	-	-	-
-	-	6540	4020	-	1.39	-	-	-
-	1.00	29100	1700	650	0.69	-	-	-
-	-	6540	4020	-	1.52	-	-	-
-	1.00	29100	17900	650	0.72	W208PP6	DC208TT6	-
-	-	6540	4020	-	1.59	-	-	-
-	-	29100	17900	650	0.81	W208PP9	DS208TT9	AS4508BE
-	-	6540	4020	-	1.79	-	-	-
6.20	-	29100	17900	650	0.79	GW208PPB6	DS208TTR6	RAS4508AE
-	-	6540	4020	-	1.75	-	-	-
-	1.00	29100	17900	650	0.81	W208PP9	-	AS4508AD
-	-	6540	4020	-	1.79	-	-	-
-	-	29100	17900	650	0.59	-	-	-
-	-	6540	4020	-	1.30	-	-	-
-	-	29100	17900	650	0.63	-	-	-
-	-	6540	4020	-	1.39	-	-	-
-	-	29100	17900	650	0.58	W208PPB5	DS208TT5	AS4508BJ
-	-	6540	4020	-	1.28	-	-	-
-	1.00	29100	17900	650	0.59	-	-	-
-	-	6540	4020	-	1.30	-	-	-
-	1.00	29100	17900	650	0.58	W208PP5	DC208TT5	AS4508BH
-	-	6540	4020	-	1.28	-	-	-
-	-	29100	17900	650	0.75	W208PPB8	DS208TT8	AS4508EF
-	-	6540	4020	-	1.66	-	-	-
6.20	-	29100	17900	650	0.75	GW208PPB8	DS208TTR8	RAS4508EF
-	-	6540	4020	-	1.66	-	-	-
-	6.20	29100	17900	650	0.70	GW208PPB5	DS208TTR5	RAS4508BJ
-	-	6540	4020	-	1.54	-	-	-
-	1.00	29100	17900	650	0.75	WS208PP8	DC208TT8	AS4508BD
-	-	6540	4020	-	1.66	-	-	-
-	-	32500	20500	600	0.70	-	-	-
-	-	7310	4610	-	1.54	-	-	-
-	-	32500	20500	600	0.78	-	-	-
-	-	7310	4610	-	1.72	-	-	-
-	-	32500	20500	600	0.83	-	-	-
-	-	7310	4610	-	1.83	-	-	-
-	-	35000	23200	550	0.95	W210PPB4	DS210TT4	AS4510F
-	-	7870	5220	-	2.11	-	-	-

Please check availability

PDFN AND DNF SERIES
PDF AND DF SERIES

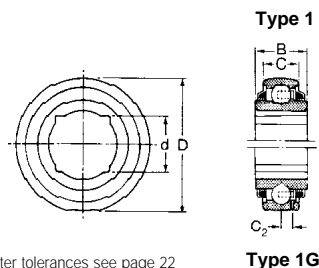

Note: For outer ring outside diameter tolerances see page 22

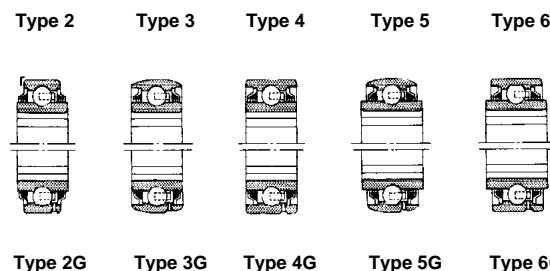

Square shaft	RHP designation		Type	Dimensions				
	spherical outside diameter	parallel outside diameter		square bore	outside diameter			
				d	tolerance	D	B	C
mm inches				nominal	nominal to minus	nominal		
				mm				
				inches				
1 1/8	PDFN150/9GY		3G	29,44	0,20	90,000	30,16	30,16
1 1/8		PDF150/9Y	4	1-159	-008	3-5433	1-188	1-188
1 1/8				29,44	0,20	90,000	30,16	30,16
1 1/8		PDF150/9GY	4G	1-159	-008	3-5433	1-188	1-188
1 1/8	PDFN250/9Y		5	29,44	0,20	90,000	36,51	30,16
				1-159	-008	3-5433	1-438	1-188
30	DNF240/9AY		1	30,94	0,20	80,000	36,51	21,00
30				1-218	-008	3-1496	1-438	-827
30	DNF145/9AY		1	30,94	0,20	85,000	30,16	22,00
				1-218	-008	3-3465	1-188	-866
30		DF245/9AY	2	30,94	0,20	85,000	36,51	22,00
				1-218	-008	3-3465	1-438	-866
1 1/4	DNF145/10Y		1	32,95	0,20	85,000	30,16	22,00
				1-297	-008	3-3465	1-188	-866
1 1/4	DNF245/10Y		1	32,95	0,20	85,000	36,51	22,00
				1-297	-008	3-3465	1-438	-866
1 1/4	DNF245/10GY		1G	32,95	0,20	85,000	36,51	22,00
				1-297	-008	3-3465	1-438	-866
1 1/4	PDFN245/10Y		5	32,95	0,20	85,000	36,51	30,16
				1-297	-008	3-3465	1-438	1-188
1 1/4	PDFN145/10GY		5G	32,95	0,20	85,000	36,51	30,16
				1-297	-008	3-3465	1-438	1-188
1 1/4		PDF245/10Y	6	32,95	0,20	85,000	36,51	30,16
				1-297	-008	3-3465	1-438	1-188
1 1/4	DNF155/10Y		1	32,95	0,20	100,000	33,34	25,00
				1-297	-008	3-9370	1-312	-984
1 1/2	DNF155/12AY		1	39,12	0,20	100,000	33,34	25,00
				1-540	-008	3-9370	1-312	-984
1 1/2	PDFN155/12Y		3	39,12	0,20	100,000	33,34	33,34
				1-540	-008	3-9370	1-312	1-312
1 1/2	PDFN155/12GY		3G	39,12	0,20	100,000	33,34	33,34
				1-540	-008	3-9370	1-312	1-312
1 1/2		PDF155/12Y	4	39,12	0,20	100,000	33,34	33,34
				1-540	-008	3-9370	1-312	1-312
1 1/2		PDF55/12GY	4G	39,12	0,20	100,000	33,34	33,34
				1-540	-008	3-9370	1-312	1-312
40	DNF155/12AY		1	41,20	0,20	100,000	33,34	25,00
				1-622	-008	3-9370	1-312	0,984
40		PDF155/12AY	4	41,20	0,20	100,000	33,34	33,34
				1-622	-008	3-9370	1-312	1-312

C ₂	r	ISO load ratings		Rec. max speed	Mass (approx.)	Interchange data		
		dynamic C _r	static C _{0r}			Fafnir	BCA	NDH
mm inches		newtons lbf	newtons lbf	rev/min	kg lb			
6,70	-	35000	23200	550	0,95	GW210PPB4	DS210TTR4	RAS4510F
-264	-	7870	5220		2-11			
	1,00	35000	23200	550	0,95	W210PP4	DC210TT4	AS4510B
	-039	7870	5220		2-11			
6,70	1,00	35000	23200	550	0,95	GW210PP4	DC210TTR4	RAS4510B
-264	-039	7870	5220		2-11			
	-	35000	23200	550	1,01	W210PPB6	DS210TT6	
	-	7870	5220		2-25			
-	-	29100	17900	650	0,61			
-	-	6540	4020		1-35			
-	-	32500	20500	600	0,67			
-	-	7310	4610		1-48			
-	-	32500	20500	600	0,73			
-	-	7310	4610		1-61			
-	-	32500	20500	600	0,65			
-	-	7310	4610		1-43			
-	-	32500	20500	600	0,75	W20PPB8	DS209TTR8	AS4509EF
-	-	7310	4610		1-66			
6,50	-	32500	20500	600	0,75	GW209PPB8	DS209TTR8	RAS4509EF
-256	-	7310	4610		1-66			
-	-	32500	20500	600	0,79	W209PPB5	DS209TT5	AS4509A
-	-	7310	4610		1-75			
6,50	-	32500	20500	600	0,79	GW209PPB5	DS209TTR5	RAS4509A
-256	-	7310	4610		1-75			
-	1,00	32500	20500	600	0,79		DC209TT5	AS4509AD
-	-039	7310	4610		1-75			
-	-	43500	29200	500	1,32			
-	-	9780	6560		2-90			
-	-	43500	29200	500	1,16			
-	-	9780	6560		2-56			
-	-	43500	29200	500	1,26	W211PPB3	DS211TT3	AS4511BE
-	-	9780	6560		2-79			
7,40	-	43500	29200	500	1,26	GW211PPB3	DS211TTR3	RAS4511BE
-291	-	9780	6560		2-79			
-	1,50	43500	29200	500	1,26	W211PP3	DC211TT3	AS4511BD
-	-059	9780	6560		2-79			
7,40	1,50	43500	29200	500	1,26	GW211PP3	DC211TTR3	RAS4511BD
-291	-059	9780	6560		2-79			
-	-	43500	29200	500	1,19			
-	-	9780	6560		2-62			
-	1,50	43500	29200	500	1,19			
-	-059	9780	6560		2-62			

Please check availability

Self-Lube triple seal ball bearings (Disc Harrow type) Round bore

PDF AND DNF SERIES PDF AND DF SERIES

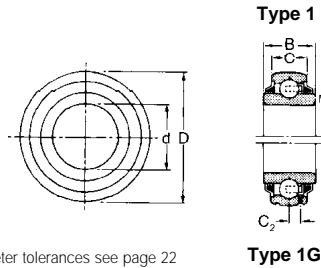

Note: For outer ring outside diameter tolerances see page 22

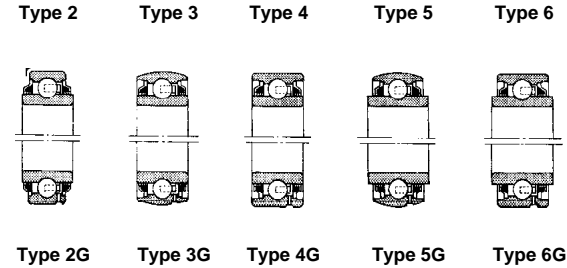

Shaft diameter	RHP designation	Type	Dimensions				
			bore diameter	tolerance	outside diameter		
	spherical outside diameter	parallel outside diameter	d nominal	nominal to minus	D nominal	B	C
mm inches			mm inches		mm inches		
1 3/16	2/DFNF140-1 3/16	1	30,176	0,013	80,000	30,16	18,00
1 3/16	PDFNF-140-1 3/16 Y	3	1-1880	-0005	3-1496	1-188	-709
1 1/4	DNF140-1 1/4 Y	1	31,763	0,013	80,000	30,16	21,00
1 1/4	DF140-1 1/4 Y	2	1-2505	-0005	3-1496	1-188	-827
1 1/4	PDFNF140-1 1/4 Y	3	31,763	0,013	80,000	30,16	21,00
1 1/2	DNF11004	1	1-2505	-0005	3-1496	1-188	-1-188
1 1/2	36/DF140-1 1/2	2	38,113	0,013	80,000	42,86	21,00
1 1/2	PDFNF140-1 1/2 Y	3	1-5005	-0005	3-1496	1-688	-827
1 1/2	PDFNF11016	5	38,113	0,013	80,000	42,86	30,16
1 1/2	28/PDNF145-1 1/2	3	1-5005	-0005	3-1496	1-688	-1-188
1 1/2	28/PDN145-1 1/2 G	3G	38,990	0,250	85,000	30,16	30,16
40	DNF140-40GY	1G	1-535	-010	3-3465	1-188	-1-188
45	DNF145-45Y	1	45,000	0,013	85,000	30,16	22,0
45	PDFNF145-45Y	3	1-7717	-0005	3-3465	1-188	-866
45	PDFNF145-45GY	3G	45,000	0,013	85,000	30,16	23,00
45	DNF11006	1G	1-7717	-0005	3-3465	1-188	-1-188
1 3/4	5/PDNF150-1 3/4	3	45,340	0,250	90,000	30,16	30,16
1 5/16	DNF150-1 5/16 Y	1	1-785	-010	3-5433	1-188	-1-188
1 5/16	DF150-1 5/16 Y	2	49,225	0,013	90,000	30,16	23,00
1 5/16	PDFNF150-1 5/16 Y	3	1-9380	-0005	3-5433	1-188	-906
1 5/16	PDFNF150-1 5/16 GY	3G	49,225	0,013	90,000	30,16	23,00
1 5/16	PDF150-1 5/16 Y	4	1-9380	-0005	3-5433	1-188	-1-188
50	DNF150-50Y	1	50,000	0,013	90,000	30,16	23,00
50	DNF155-50Y	1	1-9685	-0005	3-5433	1-188	-906
			50,000	0,013	100,000	33,34	25,00
			1-9685	-0005	3-9730	1-312	-984

C2	r	ISO load ratings		Rec. max speed	Mass (approx.)	Interchange data		
		dynamic Cr	static Cor			Fafnir	BCA	NDH
mm	inches	newtons	lbf	rev/min	kg			
-	1,00	29100	17900	650	0,63	W208PPB7	DS208TT7	
-	-039	6540	4020		1-39			
-	1,00	29100	17900	650	0,71	W208PPB4	DS208TT4	
-	-039	6540	4020		1-58			
-	1,00	29100	17900	650	0,64			
-	-039	6540	4020		1-41			
-	1,00	29100	17900	650	0,64			
-	-039	6540	4020		1-41			
-	1,00	29100	17900	650	0,70			
-	-039	6540	4020		1-55			
-	1,00	29100	17900	650	0,68			
-	-039	7310	4020		1-50			
-	1,00	29100	17900	650	0,68	W208PP10	DC208TT10	
-	-039	6540	4020		1-50			
-	1,00	29100	17900	650	0,63			
-	-039	6540	4020		1-39			
-	1,00	29100	17900	650	0,72	W208PPB2	D208TT2A	
-	-039	6540	4020		1-59			
-	1,00	32500	20500	600	0,74	W209PPB4	DS209TT4	AS4509BD
-	-039	7310	4610		1-65			
6,50	1,00	32500	20500	600	0,74	GW209PPB4	DS209TTR4	RAS4509BD
-256	-039	7310	4610		1-65			
6,20	1,00	29100	17900	650	0,62			
-244	-039	6540	4020		1-37			
-	1,00	32500	20500	600	0,63			
-	-039	7310	4610		1-39			
-	1,00	32500	20500	600	0,65	W209PPB2	DS209TT2	AS4509BE
-	-039	7310	4610		1-44			
6,50	1,00	32500	20500	600	0,65	GW209PPB2	DS209TTR2	RAS4509BE
-256	-039	7310	4610		1-44			
6,50	1,00	32500	20500	600	0,62	GW209PPB11	DS209TTR10	
-256	-039	7310	4610		1-37			
-	1,00	35000	23200	550	0,79	W210PPB5	DS210TT5	AS4510D
-	-039	7870	5220		1-75			
-	1,00	35000	23200	550	0,64			
-	-039	7870	5220		1-41			
-	1,00	35000	23200	550	0,64			
-	-039	7870	5220		1-41			
-	1,00	35000	23200	550	0,66	W210PPB2	DS210TT2	
-	-039	7870	5220		1-46			
6,70	1,00	35000	23200	550	0,66	GW210PPB2	DS210TTR2	
-264	-039	7870	5220		1-46			
-	1,00	35000	23200	550	0,70	W210PP2	DC210TT2	
-	-039	7870	5220		1-56			
-	1,00	35000	23200	550	0,63			
-	-039	7870	5220		1-39			
-	1,50	43500	29200	500	0,77			
-	-059	9780	6560		1-70			

Please check availability

PDF AND DNF SERIES
PDF AND DF SERIES

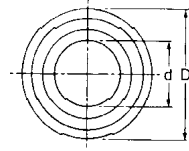

Type 1

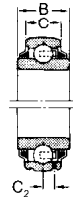

Type 1G

Note: For outer ring outside diameter tolerances see page 22

Type 2

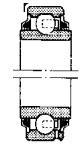

Type 2G

Type 3

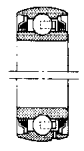

Type 3G

Type 4

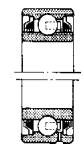

Type 4G

Type 5

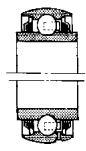

Type 5G

Type 6

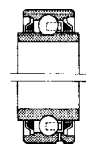

Type 6G

Shaft diameter	RHP designation		Type	Dimensions		outside diameter		
	spherical outside diameter	parallel outside diameter		bore diameter		D	B	C
				d nominal	tolerance nominal to minus	D nominal	B	C
mm inches				mm inches				
50	DNF155-50GY		1G	50.000	0,013	100.000	33.34	25.00
				1-9685	-0005	3-9370	1-312	-984
2 ³ / ₁₆	DNF155-2³/₁₆Y		1	55.578	0,015	100.000	33.34	25.00
				2-1881	-0006	3-9370	1-312	-984
2 ³ / ₁₆	PDNF155-2³/₁₆Y		3	55.578	0,015	100.000	33.34	33.34
				2-1881	-0006	3-9370	1-312	1-312
2 ³ / ₁₆	PDNF155-2³/₁₆GY		3G	55.578	0,015	100.000	33.34	33.34
				2-1881	-0006	3-9370	1-312	1-312
2 ³ / ₁₆		PDF155-2³/₁₆Y	4	55.578	0,015	100.000	33.34	33.34
				2-1881	-0006	3-9370	1-312	1-312
2 ³ / ₁₆		PDF155-2³/₁₆GY	4G	55.578	0,015	100.000	33.34	33.34
				2-1881	-0006	3-9370	1-312	1-312

C ₂	r	ISO load ratings		Rec. max speed	Mass (approx.)	Interchange data		
		dynamic C _r	static C _{0r}			Fafnir	BCA	NDH
mm inches		newtons lbf	newtons lbf	rev/min	kg lb			
7,40	1,50	43500	29200	500	0,77			
-291	-059	9780	6560		1-70			
-	1,50	43500	29200	500	0,91			
-	-059	9780	6560		2-00			
-	1,50	43500	29200	500	0,96	W211PPB2	DS211TT2	
-	-059	9780	6560		2-13			
7,40	1,50	43500	29200	500	0,96	GW211PPB2	DS211TTR2	
-291	-059	9780	6560		2-13			
-	1,50	43500	29200	500	1,05	W211PP2	DS211TT2	AS4511C
-	-059	9780	6560		2-33			
7,40	1,50	43500	29200	500	1,05	GW211PP2	DC211TTR2	RAS4511C
-291	-059	9780	6560		2-33			

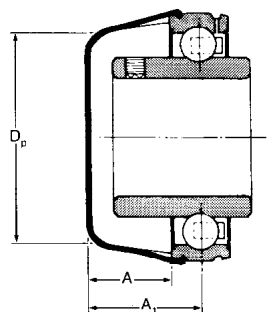

The Protector range

RHP designation	Dimensions			Basic bearing insert
	Dp	A	A1	
	mm			
	inches			
20P	37,0	23,0	30,0	1020
	1.457	.906	1.181	
25P	42,5	23,0	30,5	1025
	1.673	.906	1.201	
30P	50,5	26,5	34,5	1030
	1.988	1.043	1.358	
35P	60,5	28,5	37,0	1035
	2.382	1.122	1.457	
40P	67,5	30,5	39,5	1040
	2.657	1.201	1.555	
45P	72,0	30,0	39,5	1045
	2.835	1.181	1.555	
50P	76,0	32,5	42,5	1050
	2.992	1.280	1.673	
55P	85,0	37,5	48,0	1055
	3.346	1.476	1.890	
60P	94,0	40,5	51,5	1060
	3.700	1.594	2.028	

The following table shows the range of units which can be fitted with a Protector and indicates the right Protector to select.

Protectors for Self-Lube units

Bore size	Self-Lube Unit													
	NP	SFT	SNP	LFTC	FC	ST	BT	SLFEP	SLFTP	MFC	SCHB	NP-K	MP	
	NP-A	SFT-A	SNP-A	LFTC-A	FC-A	ST-A	BT-A	SLFEP-A	SLFTP-A		SCH	MP-K	MSF	
	NP-EC	SFT-EC	SNP-EC	LFTC-EC	FC-EC	ST-EC	BT-EC	SLFEP-EC	SLFTP-EC			MSF-K	MSFT	
	NP-DEC	SFT-DEC	SNP-DEC	LFTC-DEC	FC-DEC	ST-DEC		SLFEP-DEC	SLFTP-DEC			MSF-K	MST	
	SL	SLC	CNP	SLFLP								MST-K	MSC	
	SL-A	SLC-A	CNP-A	SLFLP-A										
	SL-EC	SLC-EC	CNP-EC	SLFLP-EC										
	SL-DEC	SLC-DEC	CNP-DEC	SLFLP-DEC										
	SF													
	SF-A													
	SF-EC													
	SF-DEC													
20, 3/4	20P	20P	20P	20P	20P	20P	-	20P	-	-	20P	25P	-	
25, 7/8, 15/16, 1	25P	25P	25P	25P	25P	25P	25P	25P	25P	30P	30P	30P	30P	
30, 1 1/8	30P	30P	30P	30P	30P	30P	-	30P	30P	35P	35P	35P	35P	
1 3/16	30P	30P	30P	30P	30P	30P	-	30P	30P	35P	35P	35P	35P	
1 1/4	35P	35P	35P	30P	35P	35P	35P	30P	30P	35P	35P	40P	35P	
35, 1 3/8	35P	35P	35P	35P	35P	35P	35P	35P	35P	40P	35P	40P	40P	
1 7/16	35P	35P	35P	35P	35P	35P	35P	35P	35P	40P	40P	45P	40P	
40, 1 1/2	40P	40P	40P	-	40P	40P	-	40P*	-	40P	40P	45P	45P	
45, 1 5/8	45P	45P	45P	-	45P	45P	-	45P*	-	50P	50P	50P	50P	
1 11/16, 1 3/4	45P	45P	45P	-	45P	45P	-	45P*	-	50P	50P	50P	50P	
50, 1 7/8, 1 15/16	50P	-	-	-	50P	50P	-	50P*	-	55P	50P	55P	55P	
2	55P	55P	-	-	50P	55P	-	55P*	-	55P	50P	55P	55P	
55, 2 1/8, 2 3/16	55P	55P	-	-	55P	55P	-	55P*	-	60P	60P	-	60P	
2 1/4	60P	60P	-	-	60P	60P	-	60P*	-	60P	60P	-	60P	
60, 2 3/8, 2 7/16	60P	60P	-	-	60P	60P	-	60P*	-	60P	60P	-	-	

*Please check availability of units.

Note 1 The appropriate Protector is determined by the basic bearing insert group.

2 When a pressing from the series SLFL, SLFE or SLFT is fitted with a Protector, the unit reference includes the letter 'P', e.g. SLFEP-25EC.

LF series

A range of three bolt spheroidal graphite iron housed units, available in bore sizes 25mm to 35mm and 1" to 1 7/16". These are non-re-greaseable.

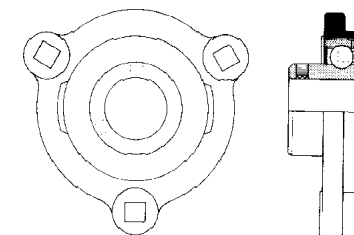

LF series

AR-A series, AR-EC series

The AR series is the bearing and rubber cartridge used in the LPBR unit (Pages 78 and 79). Available as a series for users who have their own housing. Bore sizes 12mm to 30mm and 1/2" to 1 1/4".

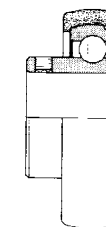

AR-A series

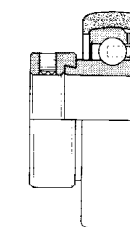

AR-EC series

SRM-EC series

Rubber housed units fitted with the 1120 or 1125 type inserts. Available in bore sizes 20mm, 3/4", 25mm, 7/8" and 1" with eccentric collar or set screw lock.

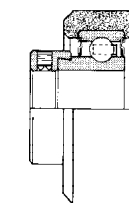

SRM-EC series

SRC-EC series

Rubber housed units suitable for the air conditioning market, two housings each with an outside diameter of 64,5mm and in bore sizes 20mm to 25mm and 3/4" to 1" are available.

Special SRC types

Bore sizes 20mm and 3/4". Offered with eccentric collar lock. (SRC11004 and SRC11005 respectively.)

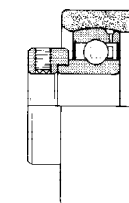

SRC-EC series

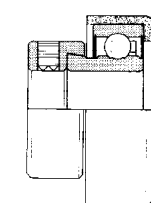

Special SRC types

Please check availability.

2300-EC extra light series

The 2300-EC series is an extra light bearing available in bore sizes 20mm to 30mm and 3/4" to 1 3/16".

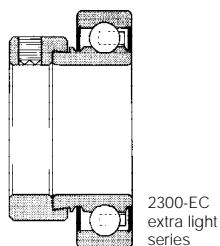

2300-EC extra light series

1600-G series, 1600-HG series

A range of spherical outside diameter deep groove wide inner ring ball bearings with either round or hexagonal bores.

These are re-greaseable and available in round bore sizes 20mm to 75mm and 3/4" to 2 15/16" and hexagonal bore sizes 7/8" AF to 1 1/2" AF and 22mm AF to 38mm AF.

The standard Self-Lube cage and seals are fitted.



1600-G series

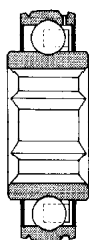

1600-HG series

1700 series, 1700-H series

As 1600-G, 1600-HG but with parallel outside diameters, although this range is not re-greaseable.

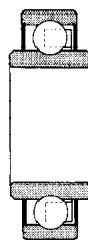

1700 series

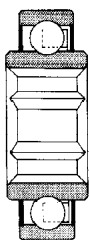

1700-H series

Conversion factors for British and S.I. Units

Quantity	Conversions
Mass	1 lb = 0.4536 kg 1 kg = 2.205 lb
Force	1 lbf = 4.448 N 1 N = 0.2248 lbf
Torque	1 lbf ft = 1.3558 Nm 1 lbf in = 0.1130 Nm 1 Nm = 0.7376 lbf ft 1 Nm = 8.850 lbf in

Temperature conversion table

°C	°C or °F	°F	°C	°C or °F	°F	°C	°C or °F	°F	°C	°C or °F	°F	°C	°C or °F	°F	°C	°C or °F	°F			
-110 to 210																				
-79	-110	-166	-46	-50	-58	-17.2	1	33.8	-13.9	7	44.6	4.4	40	104	37.7	100	212	71	160	320
-73	-100	-148	-40	-40	-40	-16.6	2	35.6	-13.3	8	46.4	9.9	50	122	43	110	230	76	170	338
-68	-90	-130	-34	-30	-22	-16.1	3	37.4	-12.7	9	48.2	15.6	60	140	49	120	248	83	180	356
-62	-80	-112	-29	-20	-4	-15.5	4	39.2	-12.2	10	50.0	21.0	70	158	54	130	266	88	190	374
-57	-70	-94	-23	-10	14	-15.0	5	41.0	-6.6	20	68.0	26.8	80	176	60	140	284	93	200	392
-55	-60	-76	-17.7	0	32	-14.4	6	42.8	-1.1	30	86.0	32.1	90	194	65	150	302	99	210	410
220 to 630																				
104	220	428	138	280	536	171	340	644	204	400	752	238	460	860	271	520	968	304	580	1076
110	230	446	143	290	554	177	350	662	210	410	770	243	470	878	276	530	986	310	590	1094
115	240	464	149	300	572	182	360	680	215	420	788	249	480	896	282	540	1004	315	600	1112
121	250	482	154	310	590	188	370	698	221	430	806	254	490	914	288	550	1022	321	610	1130
127	260	500	160	320	608	193	380	716	226	440	824	260	500	932	293	560	1040	326	620	1148
132	270	518	165	330	626	199	390	734	232	450	842	265	510	950	299	570	1058	332	630	1166
640 to 1000																				
338	640	1184	371	700	1292	404	760	1400	432	810	1490	460	860	1580	487	910	1670	515	960	1760
343	650	1202	376	710	1310	410	770	1418	438	820	1508	465	870	1598	493	920	1688	520	970	1778
349	660	1220	382	720	1328	415	780	1436	443	830	1526	471	880	1616	498	930	1706	526	980	1796
354	670	1238	387	730	1346	421	790	1454	449	840	1544	476	890	1634	504	940	1724	532	990	1814
360	680	1256	393	740	1364	426	800	1472	454	850	1562	482	900	1652	510	950	1742	538	1000	1832
365	690	1274	399	750	1382															

Explanatory Note

The bold type numbers indicate the degrees of temperature, Fahrenheit or Centigrade, whichever is required to be converted. To convert Fahrenheit to Centigrade the equivalent temperature is given on the left of the bold type. To convert Centigrade to Fahrenheit the equivalent temperature is given on the right of the bold type.

Metric/inch conversions

mm	0	10	20	30	40	50	60	70	80	90
0	inches	0.39370	0.78740	1.18110	1.57480	1.96850	2.36220	2.75590	3.14961	3.54331
1	0.03937	0.43307	0.82677	1.22047	1.61417	2.00787	2.40157	2.79528	3.18898	3.58268
2	0.07874	0.47244	0.86614	1.25984	1.65354	2.04724	2.44094	2.83464	3.22835	3.62205
3	0.11811	0.51181	0.90551	1.29921	1.69291	2.08661	2.48031	2.87402	3.26772	3.66142
4	0.15748	0.55118	0.94488	1.33858	1.73228	2.12598	2.51968	2.91338	3.30709	3.70079
5	0.19685	0.59055	0.98425	1.37795	1.77165	2.16535	2.55906	2.95276	3.34646	3.74016
6	0.23622	0.62992	1.02362	1.41732	1.81102	2.20472	2.59842	2.99212	3.38583	3.77953
7	0.27559	0.66929	1.06299	1.45669	1.85039	2.24409	2.63780	3.03150	3.42520	3.81890
8	0.31496	0.70866	1.10236	1.49606	1.88976	2.28346	2.67716	3.07087	3.46457	3.85827
9	0.35433	0.74803	1.14173	1.53543	1.92913	2.32283	2.71654	3.11024	3.50394	3.89764

mm	0	100	200	300	400	500	600	700	800	900
0	inches	3.93701	7.87402	11.8110	15.7480	19.6850	23.6220	27.5590	31.4961	34.4331
5	0.19685	4.13386	8.07087	12.0079	15.9449	19.8819	23.8189	27.7559	31.6929	35.6299
10	0.39370	4.33071	8.26772	12.2047	16.1417	20.0787	24.0157	27.9528	31.8898	35.8268
15	0.59055	4.52756	8.46457	12.4016	16.3386	20.2756	24.2126	28.1496	32.0866	36.0236
20	0.78740	4.72441	8.66142	12.5984	16.5354	20.4724	24.4094	28.2835	32.2205	
25	0.98425	4.92126	8.85827	12.7953	16.7323	20.6693	24.6063	28.4803	32.4803	36.4173
30	1.18110	5.11811	9.05512	12.9921	16.9291	20.8661	24.8031	28.7402	32.6772	36.6142
35	1.37795	5.31496	9.25197	13.1890	17.1260	21.0630	25.0000	28.9370	32.8740	36.8110
40	1.57480	5.51181	9.44882	13.3858	17.3228	21.2598	25.1968	29.1338	33.0709	37.0079
45	1.77165	5.70866	9.64567	13.5827	17.5197	21.4567	25.3937	29.3307	33.2677	37.2047
50	1.96850	5.90551	9.84252	13.7795	17.7165	21.6535	25.5906	29.5276	33.4646	37.4016
55	2.16535	6.10236	10.0394	13.9764	17.9134	21.8504	25.7874	29.7244	33.6614	37.5984
60	2.36220	6.29921	10.2362	14.1732	18.1102	22.0472	25.9842	29.9212	33.8583	37.7953
65	2.55906	6.49606	10.4331	14.3701	18.3071	22.2441	26.1811	30.1181	34.0551	37.9921
70	2.75590	6.69291	10.6299	14.5669	18.5039	22.4409	26.3780	30.3150	34.2520	38.1890
75	2.95276	6.88976	10.8268	14.7638	18.7008	22.6378	26.5748	30.5118	34.4488	38.3858
80	3.14961	7.08661	11.0236	14.9606	18.8976	22.8346	26.7716	30.7087	34.6457	38.5827
85	3.34646	7.28346	11.2205	15.1575	19.0945	23.0315	26.9685	30.9055	34.8425	38.7795
90	3.54331	7.48031	11.4173	15.3543	19.2913	23.2283	27.1654	31.1024	35.0394	38.9764
95	3.74016	7.67716	11.6142	15.5512	19.4882	23.4252	27.3622	31.2992	35.2362	39.1732

mm	inches	mm	inches	mm	inches
0.001	0.000039	0.01	0.00039	0.1	0.00394
0.002	0.000079	0.02	0.00079	0.2	0.00787
0.003	0.000118	0.03	0.00118	0.3	0.01181
0.004	0.000157	0.04	0.00157	0.4	0.01575
0.005	0.000197	0.05	0.00197	0.5	0.01968
0.006	0.000236	0.06	0.00236	0.6	0.02362
0.007	0.000276	0.07	0.00276	0.7	0.02756
0.008	0.000315	0.08	0.00315	0.8	0.03150
0.009	0.000354	0.09	0.00354	0.9	0.03543

1 METRE = 39.37 INCHES

Inch/metric conversions

inches	mm	inches	mm	inches	mm
1/32	1/64 0.015625 0.3969	11/32	0.34375 8.7312	43/64	0.671875 17.0656
	0.03125 0.7938	23/64	0.359375 9.1281	11/16	0.6875 17.4625
1/16	3/64 0.046875 1.1906		0.375 9.5250	45/64	0.703125 17.8594
	0.0625 1.5875	3/8	0.390625 9.9219	23/32	0.71875 18.2562
		5/16	0.40625 10.3188	47/64	0.734375 18.6531
3/32	5/64 0.078125 1.9844	13/32	0.421875 10.7156	3/4	0.75 19.0500
	0.09375 2.3812	27/64	0.4375 11.1125	49/64	0.765625 19.4469
1/8	7/64 0.109375 2.7781		0.453125 11.5094	25/32	0.78125 19.8438
	0.125 3.1750	29/64	0.46875 11.9062	51/64	0.796875 20.2406
		9/16	0.484375 12.3031	13/16	0.8125 20.6375
5/32	9/64 0.140625 3.5719	15/32	0.5 12.7000	53/64	0.828125 21.0344
	0.15625 3.9688	31/64	0.515625 13.0969	27/32	0.84375 21.4312
3/16	11/64 0.171875 4.3656		0.53125 13.4938	55/64	0.859375 21.8281
	0.1875 4.7625	17/32	0.546875 13.8906	7/8	0.875 22.2250
7/32	13/64 0.203125 5.1594		0.5625 14.2875	57/64	0.890625 22.6219
	0.21875 5.5562	9/16	0.578125 14.6844	29/32	0.90625 23.0188
1/4	15/64 0.234375 5.9531		0.59375 15.0812	59/64	0.921875 23.4156
	0.25 6.3500	5/8	0.609375 15.4781	15/16	0.9375 23.8125
		17/64	0.265625 6.7469	61/64	0.953125 24.2094
9/32	17/64 0.28125 7.1438		0.28125 7.1438	31/32	0.96875 24.6062
	0.296875 7.5406	5/8	0.3125 7.9375	63/64	0.984375 25.0031
5/16	19/64 0.296875 7.5406		0.328125 8.3344		
	0.3125 7.9375				
	21/64 0.328125 8.3344				

inches	0	1	2	3	4	5	6	7	8	9	10
0	mm	25.4000	50.8000	76.2000	101.6000	127.0000	152.4000	177.8000	203.2000	228.6000	254.0000
1/8	1/16	1.5875	26.9875	52.3875	77.7875	103.188	128.588	153.988	179.388	204.788	230.188
	3/16	3.1750	28.5750	53.9750	79.3750	104.775	130.175	155.575	180.975	206.375	231.775
1/4		4.7625	30.1625	55.5625	80.9625	106.362	131.762	157.162	182.562	207.962	233.362
	5/16	6.3500	31.7500	57.1500	82.5500	107.950	133.350	158.750	184.150	209.550	234.950
	3/8	7.9375	33.3375	58.7375	84.1375	109.538	134.938	160.338	185.738	211.138	236.538
	7/16	9.5250	34.9250	60.3250	85.7250	111.125	136.525	161.925	187.325	212.725	238.125
1/2		11.1125	36.5125	61.9125	87.3125	112.712	138.112	163.512	188.912	214.312	239.712
	9/16	12.7000	38.1000	63.5000	88.9000	114.300	139.700	165.100	190.500	215.900	241.300
	5/8	14.2875	39.6875	65.0875	90.4875	115.888	141.288	166.688	192.088	217.488	242.888
	11/16	15.8750	41.2750	66.6750	92.0750	117.475	142.875	168.275	193.675	219.075	244.475
3/4		17.4625	42.8625	68.2625	93.6625	119.062	144.462	169.862	195.262	220.662	246.062
	13/16	19.0500	44.4500	69.8500	95.2500	120.650	146.050	171.450	196.850	222.250	247.650
	7/8	20.6375	46.0375	71.4375	96.8375	122.238	147.638	173.038	198.438	223.838	249.238
	15/16	22.2250	47.6250	73.0250	98.4250	123.825	149.225	174.625	200.025	225.425	250.825
		23.8125	49.2125	74.6125	100.012	125.412	150.812	176.212	201.612	227.012	252.412

inches	mm	inches	mm	inches	mm	inches	mm	inches	mm
0.001	0.0254	0.007	0.1778	0.04	1.016	0.1	2.54	0.7	17.78
0.002	0.0508	0.008	0.2032	0.05	1.270	0.2	5.08	0.8	20.32
0.003	0.0762	0.009	0.2286	0.06	1.524	0.3	7.62	0.9	22.86
0.004	0.1016	0.01	0.254	0.07	1.778	0.4	10.16		
0.005	0.1270	0.02	0.508	0.08	2.032	0.5	12.70		
0.006	0.1524	0.03	0.762	0.09	2.286	0.6	15.24		

1 INCH = 25.4 MILLIMETRES

